

ASSEMBLY/ INSTALLATION RECOMMEN- DATIONS

DUROPAL XTERIOR COMPACT /
DUROPAL XTERIOR COMPACT F

MAKE
YOUR
VISIONS
WORK.

MADE IN GERMANY

TABLE OF CONTENTS

1. Ventilated Rainscreen façade	3
1.1. Advantages of Rainscreen facades	4
1.2. Sustainability	5
1.3. Rainscreen Technical requirements	6
1.4. Relevant standards	7
<hr/>	
2. DUROPAL XTERIOR COMPACT / DUROPAL XTERIOR COMPACT F	8
2.1. Duropal XTerior compact (normally flammable)	10
2.2. Duropal XTerior compact F (flame retardant)	11
2.3. Fire protection	12
2.4. Storage and Transport	14
<hr/>	
3. MACHINING	17
3.1. Off-site production on stationary systems	18
3.2. Cut to size and rework using hand-guided machines	21
<hr/>	
4. INSTALLATION	23
4.1. Visible fixing on metal substructures – for normally flammable and flame retardant façade systems	26
4.2. Concealed fixing on metal substructure	39
4.3. Visible fixing on treated timber substructure – for normally flammable façade systems	43
4.4. Balcony railings	47
<hr/>	
5. DETAILED DRAWINGS	51
5.1. Rivets on aluminium substructure	52
5.2. Secret Fix (clamp or bracket) system on aluminium substructure	53
5.3. Screw on wood substructure	54
<hr/>	
6. NOTES ON CARE AND CLEANING	56
6.1. Basic cleaning	57
6.2. Special cleaning – Graffiti	57
<hr/>	
7. RECOMMENDATIONS FOR FASTENER AND TOOL MANUFACTURERS	58
<hr/>	

Legal notices:

Note that the respective relevant and valid building regulations must be complied with. We do not accept any liability for damage caused by disregard of relevant and valid building regulations. It is the responsibility of the end user / installer to check whether design, structural calculation and fire protection requirements for the planned (construction) project are met. This document is directed at appropriately trained skilled persons, who are familiar with the basic conditions, standards and working methods for the specific trades and professions. Despite the greatest possible care when drafting the installation/assembly recommendations, it must be made clear that the responsibility for proper project planning and assembly/installation lie with the designer or the installer.

1. VENTILATED RAINSCREEN FAÇADE

Ventilated curtain walls are façades with a ventilation space (cavity) between the thermal insulation and façade panel. The ventilation cavity is connected to the outside air by supply air openings on the underside and exhaust air openings at the top of the wall or wall sections (e-g- storey-wise back ventilation) and therefore enables a continuous exchange of air.

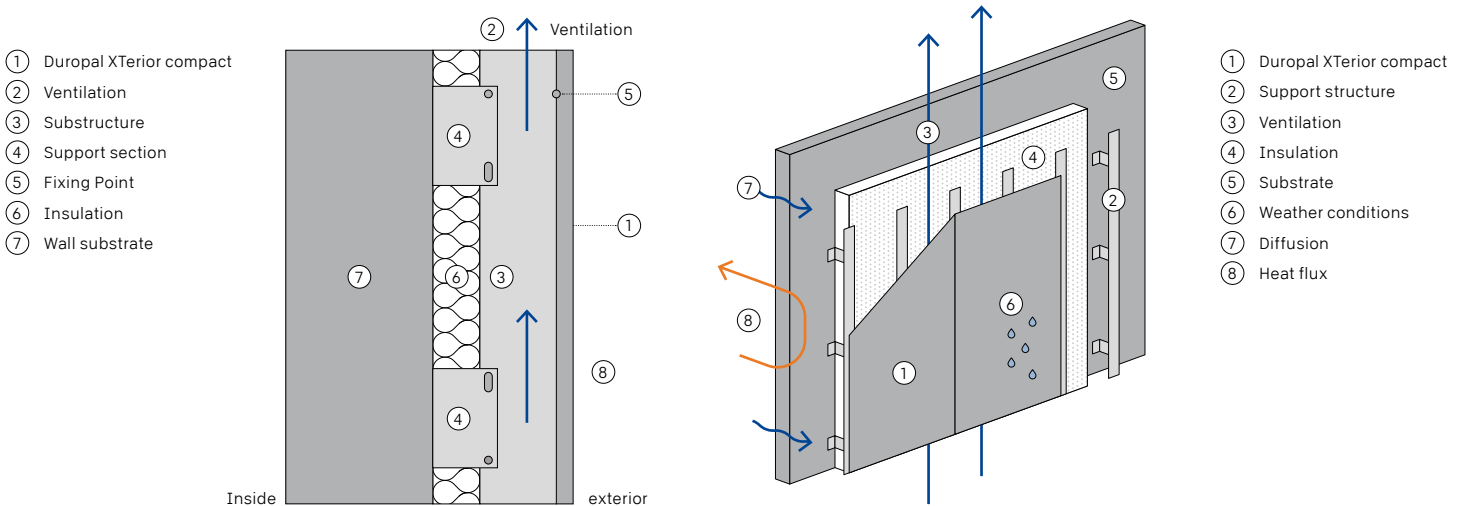

Ventilated Rainscreen façade consist of:

1. Duropal XTerior compact / Duropal XTerior compact F

They are used as protection against the weather and for façade design.

2. Ventilation

The ventilation cavity is an area between the inside of the cladding and the outside of the wall or thermal insulation, which is flowed through by outside air. This helps to protect the layers behind it from moisture, to remove moisture loads from the inside or outside and to dissipate the accumulation of heat in the summer.

3. Support section

Member that connects the substructure elements (support section, wall bracket) with each other.

4. Wall bracket/substructure

The substructure is the structural link between the wall substrate and Duropal XTerior compact (F).

5. Fixing point

Fixing points are points at which the Duropal XTerior compact / Duropal XTerior compact F is fixed on the substructure with the help of metal elements.

6. Insulation material

Thermally insulating layer between the anchoring surface (anchorage) and the ventilation cavity; depending on the material, the thermal insulation can also fulfil fire and sound insulation functions.

7. Wall substrate

The anchoring surface is the load-bearing structure of the building. It absorbs the static structural load.

The substructure is anchored in the building's structure. Surface layers, e.g. render, coatings, are generally not load-bearing.

8. Heat flux

The rear ventilation of façade systems ensures controlled air exchange to effectively prevent moisture and mould growth.

1.1. ADVANTAGES OF RAINSCREEN FACADES

The diverse properties of the Duropal XTerior compact / Duropal XTerior compact F products offer particularly large advantages when used as back ventilated façades.



Properties	Advantages
+ Weather resistance	Outstanding protection against weather effects such as rain, snow and wind
+ Robust	Very durable, low maintenance
+ Low cost	Due to the long life of the façade and possible lower maintenance costs and potentially high degree of off-site production
+ Energy efficient	Back ventilation cavity and large insulation cross-sections offer highly effective powerful building physics advantages
+ Pfliederer decorative variety	The large variety of decors of the Pfliederer Duropal XTerior compact / Duropal XTerior compact F range enables colour matching from the façade through to the interior fitting product



1.2. SUSTAINABILITY

Ventilated curtain walls with Duropal XTerior compact products offer enormous advantages for owners and developers as well as for the environment, particularly in regard to sustainable design and the implementation of buildings.

+ Sustainable forest management:	Duropal XTerior compact products are available with FSC or PEFC certification.
+ Long use periods:	The modern and timeless design options, as well as the low maintenance ensure a long use period.
+ Recyclability:	Reusability due to comprehensive recyclable material concepts and product life cycle models at the start of the building design. Thermal recovery is easily possible at the end of the use.
+ Dismantable:	Homogeneous separability of the recyclable materials is easily possible in case of conversions or at the end of the primary use phase.
+ Made in Germany:	Production at Pfeleiderer locations in Germany ensures outstanding quality standards. Made at our German Factory for shipping Worldwide.



DESIGNED FOR A FUTURE WORTH LIVING: SUSTAINABILITY AT PFLEIDERER

Through multi-stage wood utilisation (socalled cascade utilisation), wood recycling, and the use of forestry wood and industrial waste wood for high quality materials with a long service life, Pfeleiderer conserves valuable resources and actively contributes to reducing carbon emissions, air, water and soil pollution as well as the reduction of energy consumption. We control the wood mix individually, depending on the product, to achieve a perfect balance between quality requirements and resource conservation.

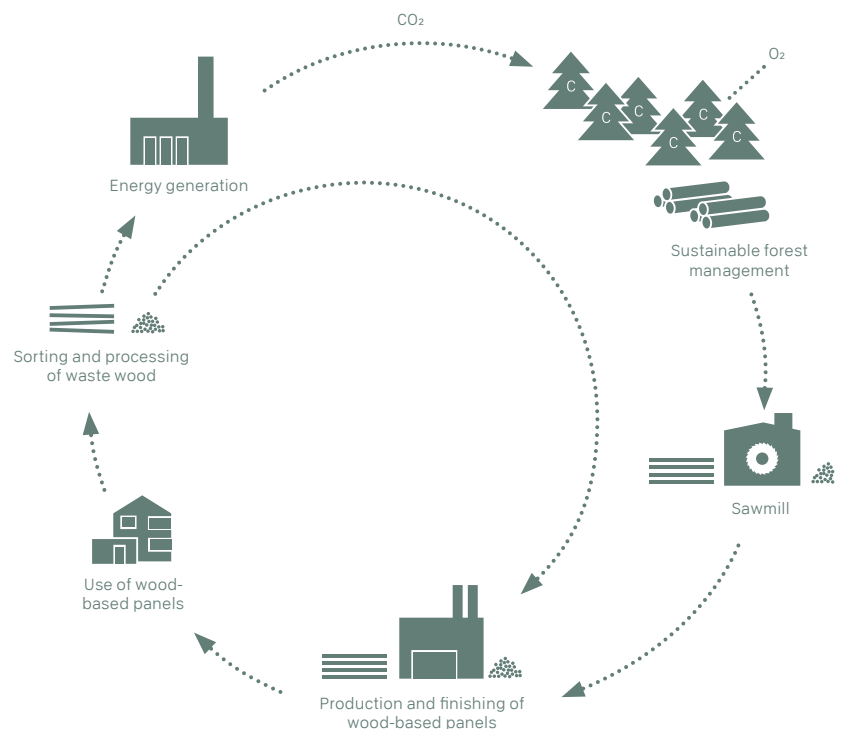

[Go to summary](#)

1.3. RAINSCREEN TECHNICAL REQUIREMENTS

Ventilated rainscreens are connected to the structure mechanically and must be stable at all times. The following loads must be taken into account for the specific property:

- Self-load
- Wind loads (suction and pressure)
- Snow and ice loads
- Impact loads
- Special loads (e.g. seismic loads, billboards)

The stability analysis for the Rainscreen system, including all individual calculations, must be performed in a checkable form to state-of-the-art standards and according to the respective European and/or national regulations. In particular, the stability analysis must include the structural calculation for the substructure, the cladding and the anchoring and connecting elements.

The fixed load is made up of the self-weight of the cladding and the substructure.

Minimum Gross Density Duropal XTerior compact / Duropal XTerior compact F

Thickness (mm)	Gross density (kg/m ³)	Weight per square (kg/m ²)
6	min. 1,350	min. 8.1
8	min. 1,350	min. 10.8
10	min. 1,350	min. 13.5

Other technical characteristics are given on the website:

Duropal XTerior compact F

Duropal XTerior compact

The wind loads must differentiate between suction and pressure. The variables to be used in the calculation depend, among other things, on the building geometry, the façade cladding design and the building location.

If applicable, special loads (impact, ball throwing or similar) must be taken into account in traffic areas (closer spacing of the substructure, etc.).





1.4. RELEVANT STANDARDS

The relevant standards, the respective (German) state building codes/national building regulations or country-specific requirements must be complied with in the design and implementation of to ventilated rainscreen façade. Regional differences are also possible within a country.

- Duropal XTerior compact – to EN 438-6:EDS / Intensive decors to EN 438-6:EGS
- Duropal XTerior compact F – to EN 438-6:EDFF

Current and comprehensive documentation, standards and approvals for Duropal XTerior compact / Duropal XTerior compact F can be found at: [Downloads \(pfleiderer.com\)](#)

**DUROPAL XTERIOR
COMPACT /
DUROPAL XTERIOR
COMPACT F**







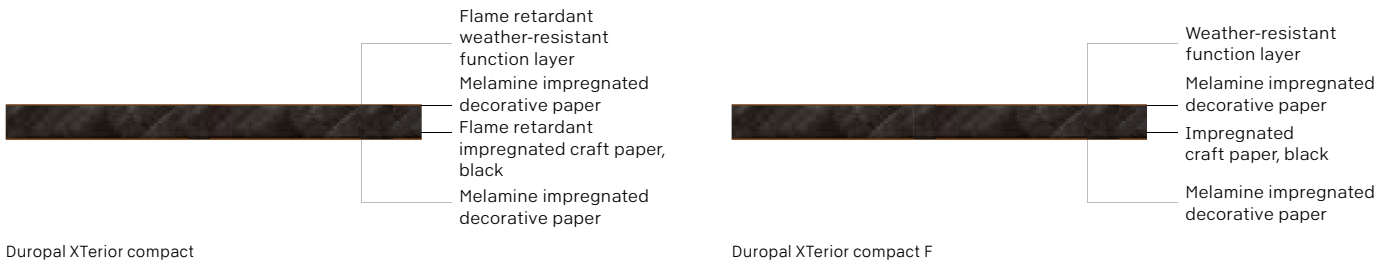



2. DUROPAL XTERIOR COMPACT / DUROPAL XTERIOR COMPACT F

Duropol XTerior compact / Duropol XTerior compact F meets the highest requirements for surface UV resistance and due to the high mechanical strength values and design freedom, is optimal for outdoor use, e.g. as façade, garden furniture, screen fences, roof soffits, balconies and playground equipment. Especially when high robustness, weather resistance and easy cleaning standards are set.



Duropol XTerior compact / Duropol XTerior compact F is characterised by its fire protection classification to EN 13501-1 B-s1, d0 and can therefore be used in public spaces and in the area of façades up to building class 5. In addition, with the Pfeleiderer façade system, Duropol XTerior compact F offers an approved structural system (aBG Z-10.3-905) for mounting on an aluminium substructure with rivets.

Areas of application	 Fire protection ¹	 Exterior use	
Product features	 Anti-graffiti	 Low swelling / moisture resistant	 UV-resistant
Product advantages	 Elegant surface finish	 Weather resistance	 High impact resistance

¹ Product Duropol XTerior compact F

Certificates and labels

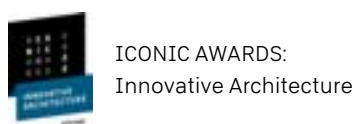

Duropol XTerior compact / Duropol XTerior compact F is delivered with a 45° bevel on the lacquered panel surface. This bevel results from the production process and should be square-edged before using the panel.

2.1. DUROPAL XTERIOR COMPACT (NORMALLY FLAMMABLE)



Compact high-pressure laminate for outdoor use in standard quality according to EN 438-6:EDS / intensive decors according to EN 438-6:EGS. With uniform black-coloured core and single-sided decorative acrylic lacquer on the top side and decorative melamine resin surface on the reverse.



CE conformity



FSC-certified



PEFC-certified



UKCA conformity





ICONIC AWARDS:
Innovative Architecture



Fire classification:

normally flammable D-s2, d0 after DIN EN 13501-1

- Can be used in Germany up to building class 2 (top floor up to max. 7 m height)
- Usability is specified in the State Building Code (Landesbauordnung – LBO) and the Model Building Code (Musterbauordnung – MBO). The specific building codes (LBO) of the federal states (“Länder”) have priority.
- The current local construction guidelines must be checked and complied with for use of Duropal XTerior compact panels in other countries.

Build height ²	Substructure	Insulation	Surface
 up to 7 meters	normally flammable	normally flammable ¹	normally flammable
 7–22 meters	normally flammable ³	non-combustible	flame retardant ³
 above 22 meters	non-combustible	non-combustible	non-combustible

¹ The FVHF (curtain façade association) recommends the use of noncombustible mineral insulation materials for all building classes of the type WAB T3 WL(P).

² Height as used by the MBO is the average height above ground level of the finished floor level of the highest storey in which a habitable space (living space) is possible.

³ If the fire propagation is limited for a sufficient length of time.

2.2. DUROPAL XTERIOR COMPACT F (FLAME RETARDANT)

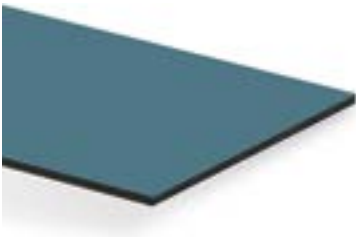

Compact high-pressure laminate for outdoor use in flame retardant quality according to EN 438-6:EDF / intensive decors according to EN 438-6:EGF. With uniform black-coloured core and single-sided decorative acrylic lacquer on the top side and decorative melamine resin surface on the reverse.

The Pfeleiderer system approval for mounting on an aluminium structure with rivets can be found in the **construction technique permit Z-10.3-905 of Duropal XTerior compact F**



CE conformity



FSC-certified



PEFC-certified



UKCA conformity



ICONIC AWARDS:
Innovative Architecture





General construction
technique permit



Fire classification:

flame retardant B-s1, d0 after DIN EN 13501-1

- Can be used in Germany up to building class 5 (top floor up to max. 22 m height)
- Usability is specified in the State Building Code (Landesbauordnung – LBO) and the Model Building Code (Musterbauordnung – MBO). The specific building codes (LBO) of the federal states (“Länder”) have priority.
- The current local construction guidelines must be checked and complied with for use of Duropal XTerior compact F panels in other countries.

Build height ²	Substructure	Insulation	Surface
 up to 7 meters	normally flammable	normal entflammbar ¹	normally flammable
 7–22 meters	normally flammable ³	non-combustible	flame retardant ³
 above 22 meters	non-combustible	non-combustible	non-combustible

¹ The FVHF (curtain façade association) recommends the use of noncombustible mineral insulation materials for all building classes of the type WAB T3 WL(P).

² Height as used by the MBO is the average height above ground level of the finished floor level of the highest storey in which a habitable space (living space) is possible.

³ If the fire propagation is limited for a sufficient length of time.

2.3. FIRE PROTECTION

The most popular façade constructions implementable with Duropal XTerior compact/Duropal XTerior compact F are presented on the following pages in relation to their reaction to fire.

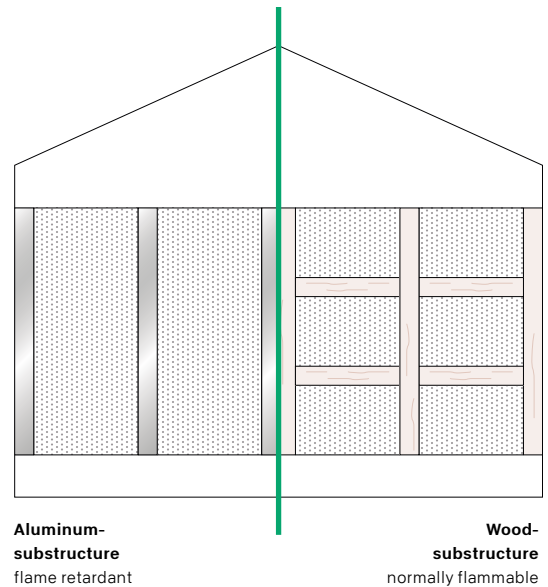

2.3.1. RIVETED ALUMINUM SUBSTRUCTURE – FLAME RETARDANT

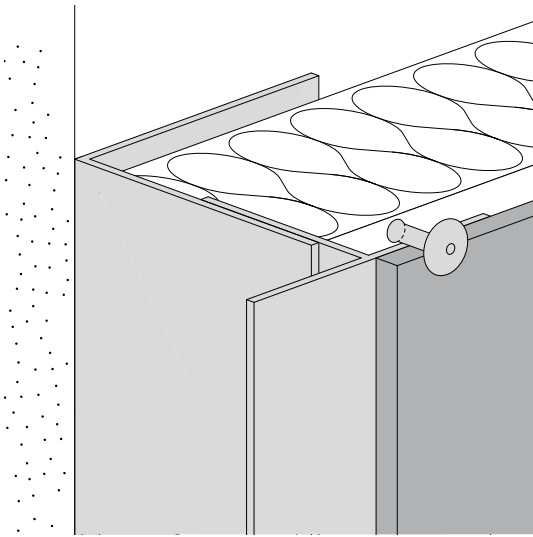

The following parameters must be adhered to in the design and execution of the façade system as a flame-retardant external wall cladding:

- The Technical Building Regulations on special fire protection measures for external wall claddings with back ventilation must be complied with
- The verification of the flame retardant properties only applies to execution of the external wall cladding on walls with proven fire resistance
- Solid mineral construction materials (masonry and concrete)
- Thermal insulation made of noncombustible thermal insulation materials (thickness ≥ 50 mm, density ≥ 35 kg/m³)
- The distance between the external wall cladding and the substrate or thermal insulation must be 20 mm
- The width of the open joints must not exceed 10 mm

If the above conditions are not met, the façade system can only be used where the building control requirement “normally flammable” is set for the external wall cladding.

Use as ceiling covering/façade soffit

The façade system with the “Duropal XTerior compact F” façade panels can be used there as ceiling covering (façade soffit), where the building control requirement is for “normally flammable” in this area.

The Pfleiderer “Duropal XTerior compact F 8 mm” façade system described in the construction technique permit Z-10.3-905 can be used in conjunction with an aluminium substructure and rivets, where the building control requirement “flame retardant” or “normally flammable” exists for external wall cladding.



2.3.2. WOOD SUBSTRUCTURE WITH SCREW FASTENING – NORMALLY FLAMMABLE

The following applies to the construction of a façade with wood substructure

- The Technical Building Regulations on special fire protection measures for external wall claddings with back ventilation must be complied with.
- Wooden support battens made of coniferous wood to DIN 1408-1 in conjunction with DIN 20000-5, grade S10 to DIN 4074 – at least 30 mm thick
- Cover battens – min. 30 x 100 mm
- Backing battens – min. 30 x 50 mm

Use as ceiling covering/façade soffit

The façade system with the “Duropal XTerior compact F” façade panels can be used there as ceiling covering (façade soffit), where the building control requirement is for “normally flammable” in this area.

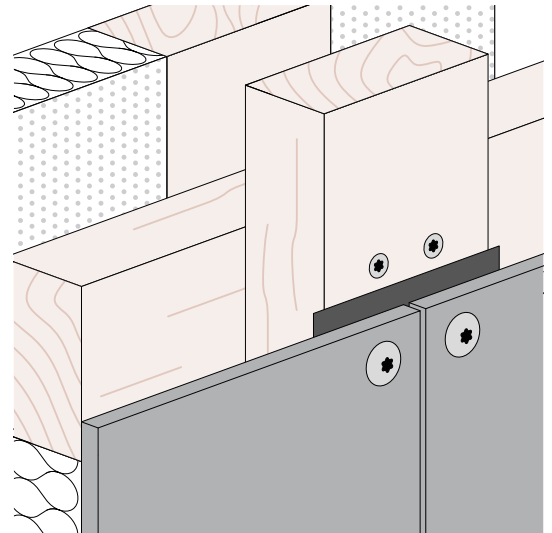

2.4. STORAGE AND TRANSPORT

neuer Link
hier?

Scan the QR code to watch our short installation videos.

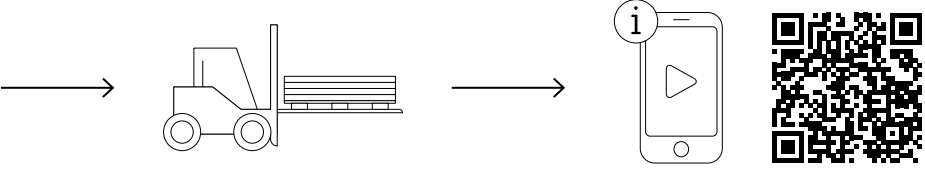

To protect the high-quality surfaces, Pfeleiderer delivers the coated surface of Duropal Xterior compact with a protective transport film. This film protects the surface of the panel against mechanical damage and dirt during transport, machining, storage and installation.

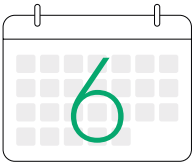

Film covered panels should be used and the film removed **within 6 months of delivery by Pfeleiderer at the latest**. One-sided film covering can cause the panel material to distort if stored improperly. We therefore recommend that the transport film cover be removed as quickly as possible after the delivery by Pfeleiderer and as early as possible in the processing/work process.

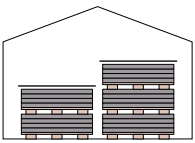

Improper storage can cause permanent deformation of Duropal Xterior compact / Duropal Xterior compact F. The panels should be stored in constant climatic conditions in **enclosed premises (approx. 15 – 25 °C, rel. humidity 40 – 60 %)**. Avoid drafts and a moisture gradient on the surfaces of the panels.

The following instructions for the storage of Duropal Xterior compact must also be noted and complied with, as otherwise irreparable damage or distortion of the panel can occur:

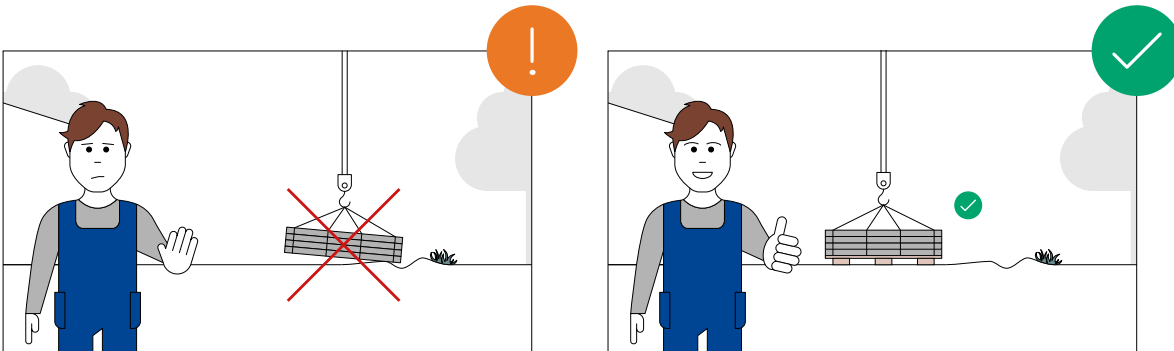

The packages must be stored on a flat, level surface.

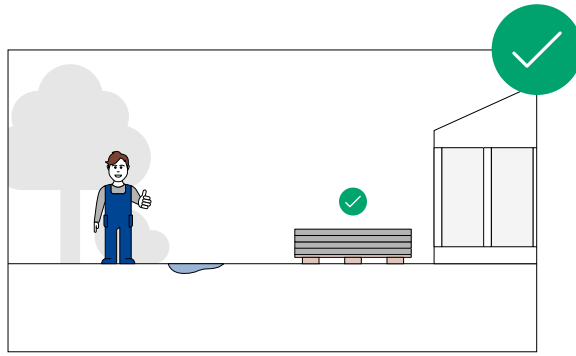
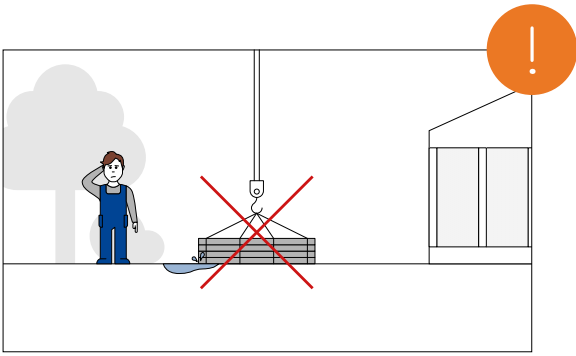

The panels must be stored preferably horizontally and without direct contact with the floor, on dry floor battens and a coated cover panel.

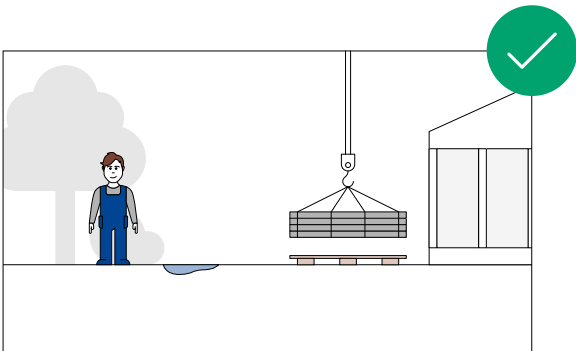

Uniformly thick floor battens must be used and placed at uniform spacings from each other (maximum 80 cm).

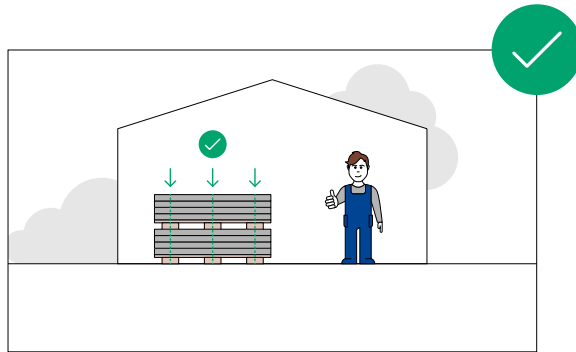
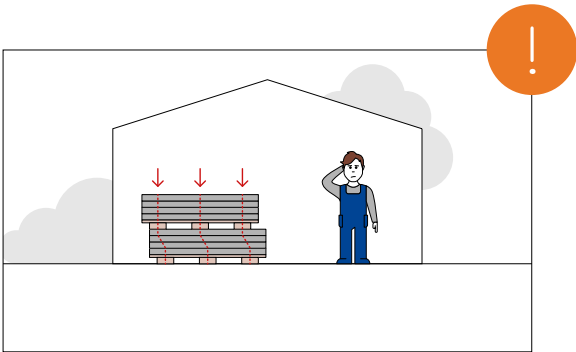

If several stacks of panels are laid on top of each other, the supporting battens must be aligned vertically on top of each other. The panels must be stacked with their edges flush to prevent damage to unprotected edges and corners.

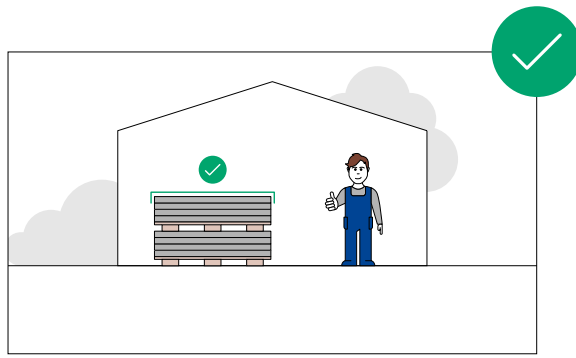
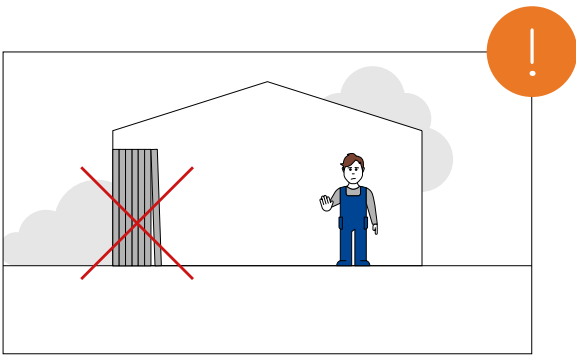

The top panel must be completely covered with a coated panel/protective.
A sufficient distance of approx. 30 cm must be maintained from walls to ensure adequate air circulation.
It is very important to avoid direct contact with the wall.

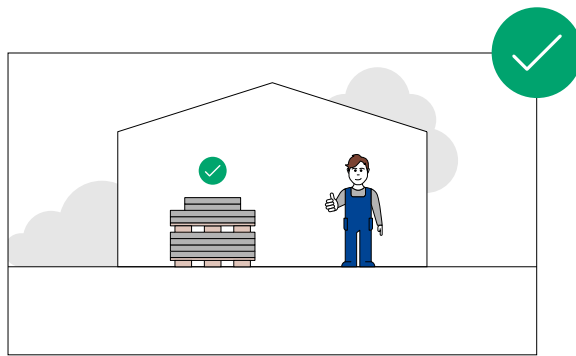
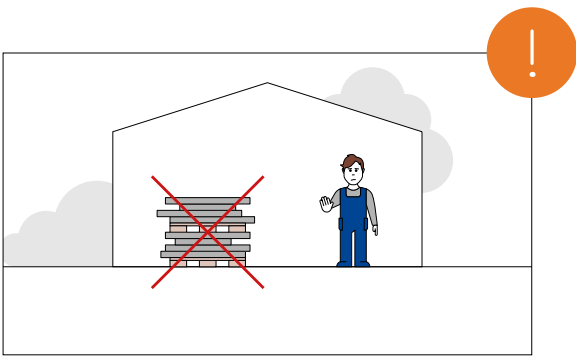

Cut panels and panels in different sizes must be stored flat on a suitable transport pallet without overhangs.
Pay attention to best possible protection from climatic changes.

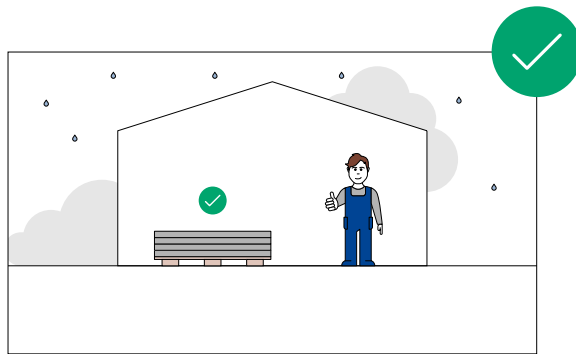
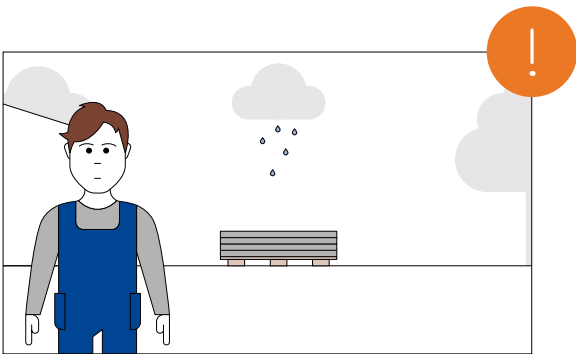

We recommend storing the panels in a dry place, protected from direct exposure to weather influences.
The panels should not be wrapped in or covered with films or tarpaulins/plastic sheeting.
Unfavourable conditions can cause condensation and water accumulations to occur under the film.
There is therefore a risk of the panels becoming warped and deformed before they are installed.

MACHINING



3. MACHINING

XTerior compact / XTerior compact F panels can be machined like hardwood with the usual woodworking tools.

Hard metal (carbide) tipped tools are required to machine XTerior compact / XTerior compact F. If larger quantities are to be machined, it is advisable to use diamond-tipped tools, as a longer tool life can be achieved with these.

Technical and personal safety are very important at Pfeleiderer.

Machining:

Pfleiderer panels meet the requirements of the ChemVerbotsV regarding formaldehyde. Wood dust can be produced during machining and use. Wood dust has been classified in the TRGS 900 "MAH values list" under III B as a substance with justified suspicion of carcinogenic potential. According to TRGS 553 the concentration of wood dust in the air at the workplace may not exceed 2 mg/m³. This usually requires the machine tools to be connected to an extraction system.

Personal protective measures: No particular measures necessary.

Pfleiderer panels are not toxic under the ChemVerbotsV (Banned Chemicals Regulations). The usual health and safety measures (work gloves, dust mask for grinding or sanding work) that apply to working of or with solid wood must also be complied with when working / installing wood-based panels.

3.1. OFF-SITE PRODUCTION ON STATIONARY SYSTEMS

Compared to other façade systems, the rainscreen wall system offers substantial cost and time advantages, particularly due to its high degree of off-site production.

For this reason, particular attention is paid to the preparatory planning and design of the façade and precise-fitting cutting to size of the elements. The less rework that has to be done on the construction site, the faster and safer the installation on site.

Due to the typical material properties of the product, horizontal or vertical panel cut-to-size saws with pressure beam and cutting unit or CNC machining centres are particularly suitable for the off-site production. The machine selection ensures fast, precise and automated machining. By using tool change magazines, the panel can be cut to size and drilled in the CNC machining centre in one operation without requiring additional handling.

Vibration-free fixing of the panel by clamping devices, pressure beam or vacuum suction cups is important for precise machining.

For work on compact laminate panels, attention must be paid to the ratio of number of teeth (Z), cutting speed (vc) and feed rate (vf). The following basic principles can be used for this.

Machining tests should always be carried out to achieve the best possible results and machine settings.

Basic calculation principles for optimum cutting results

Cutting rate

$$v_c = D \cdot \pi \cdot n / 60$$

v_c – Cutting rate

D – Tool Diameter [m]

n – Tool speed [min⁻¹]

Feed rates

$$v_f = f_z \cdot n \cdot z / 1,000$$

v_f – Feed rates [m/min]

f_z – Tooth feed rate

n – Tool speed [min⁻¹]

z – Number of teeth

Tooth feed rate

$$f_z = v_f \cdot 1,000 / n \cdot z$$

f_z – Tooth feed rate [mm]

v_f – Feed rates [m/min]

n – Tool speed [min⁻¹]

z – Number of teeth

3.1.1. SAWS

Please note the following instructions to achieve the best possible cutting result when cutting to size on stationary saws:

- Visible side (decor side) facing upwards
- Pay attention to correct sawblade projection
- Adjust the speed and number of teeth to the feed rate
- Use of a scoring saw blade is recommended for a clean cut on the underside of the panel

The entry and exit angles, and thus the quality of the cut edge, change depending on the sawblade projection. If the top cut edge is untidy, set the sawblade deeper. If the cut on the underside is untidy, set the sawblade higher. In this way, the most favourable height setting must be determined.

Depending on the diameter, a saw blade projection of 5 – 10 mm must be set for dimension and panel cut-to-size saws:

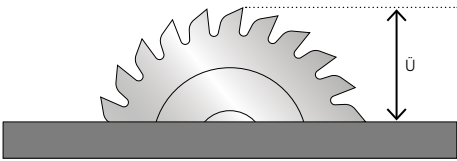

Saw blades with a large number are generally recommended for good machining quality. The recommended cutting speed v_c for circular saws is 60 – 75 m/s.

Recommended saw tooth shapes

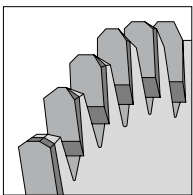

TR/TR
(Trapezoid tooth/Trapezoid tooth)

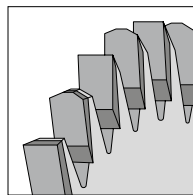

FZ/TR
(Flat tooth/Trapezoid tooth)

A scoring saw is additionally recommended for machining Duropal XTerior compact / Duropal XTerior compact F products with a decorative surface on both side, in order to avoid broken out material on the underside.

Tool recommendations

Leitz RazorCut PLUS panel sizing saw blade

For high feed rates and perfect edges

Cutting guidelines

$$v_c = 60 - 75 \text{ m/s}$$

$$f_z = 0.02 - 0.1 \text{ mm}$$

Leitz Diamaster PLUS panel sizing saw blade

For perfectly cut surfaces and lifetime durability

Cutting guidelines

$$v_c = 60 - 75 \text{ m/s}$$

$$f_z = 0.02 - 0.1 \text{ mm}$$

Leitz KON/FZ Excellent scoring circular saw blade**Matches the main circular saw blade for perfect cutting edge**

Cutting guidelines

 $v_c = 60-75 \text{ m/s}$ $f_z = 0.02-0.1 \text{ mm}$

The manufacturers of high-quality tools offer suitable cutting tools for machining wood-based panels, especially for cutting to size HPL Compact laminates. Always follow the recommendations of your tool manufacturer.

3.1.2. MILLING

Diamond-tipped (DP) routers are recommended for machining on routing machines and machining centres.

Tool recommendations

Leitz Diamaster PLUS Z 2 router**For neutral cutting with alternating axis angle**

Cutting guidelines

 $v_c = 15-20 \text{ m/s}$ Finishing: $f_z = 0.04-0.06 \text{ mm}$ Pre-milling: $f_z = 0.2-0.3 \text{ mm}$ **Leitz Diamaster PRO Z 2 profile router****For perfect 45° bevels top and bottom**

Cutting guidelines

 $v_c = 15-20 \text{ m/s}$ Finishing: $f_z = 0.04-0.06 \text{ mm}$

The manufacturers of high-quality tools offer suitable milling tools for machining HPL Compact laminates. Always follow the recommendations of your tool manufacturer.

3.1.3. DRILL

Tool recommendations

Leitz Bohrer HW-massiv Z 2**Für beidseitig ausbruchfreie Grund- und Durchgangsbohrungen in HPL**

Cutting guidelines

 $v_c = 0.7-1.6 \text{ m/s}$ $f_z = 0.15-0.3 \text{ mm}$

The manufacturers of high-quality tools offer suitable drilling tools for machining HPL Compact laminates. Always follow the recommendations of your tool manufacturer.

3.2. CUT TO SIZE AND REWORK USING HAND-GUIDED MACHINES

On-site adjustments to prefabricated elements can be necessary, especially at building edges, window reveals or other recesses. Duropal XTerior compact / Duropal XTerior compact F panels are very hard and require careful and correct handling of the machines.

It is important to ensure that the tools (hard metal or diamond cutting edges) are sharp and in a good condition, in order to achieve precise cuts.

When cutting/milling/drilling, it is important to choose the right cutting speed to prevent the panel from overheating. If the speed is too high, it can cause the cut edges to discolour or burn. A speed that is too low can cause uneven cuts.

Vibration-free fixing of the panel by clamping devices, support beam or vacuum suction cups is important for precise machining. Guide rails should be used when using hand-guided saws and miller-cutters. Always also use the fixing clamps for these to ensure precise and safe cutting.

3.2.1. SAW

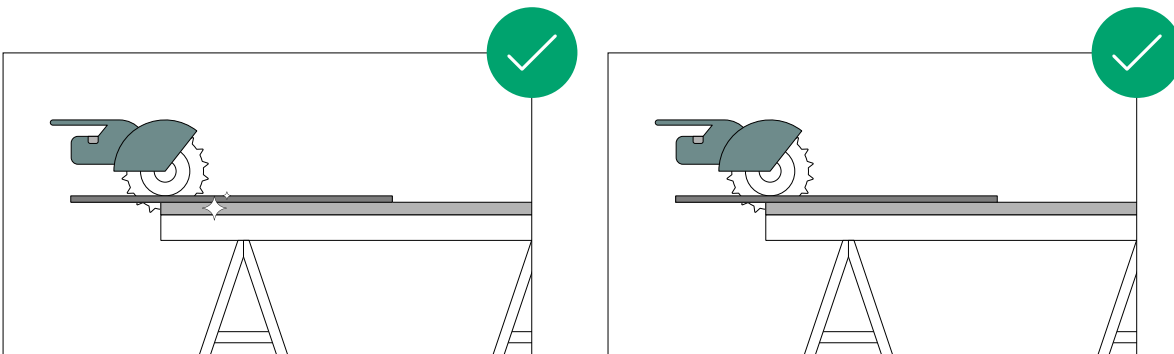

Use support beam

Speed: approx. 3,500 – 5,000 rpm

Tool recommendations

Hand-guided circular saws:

Machine	Saw blade	Immersion depth	Speed level	Guide rail
Festool TSV 60	Circular saw blade Festool	15 mm	6	Festool FS 1400/2-
Festool TSC 55	LAMINATE/HPL HW TF 52			
Festool TS 55	(Trapezoid/flat tooth – 52 teeth)			
Festool TS 60				

Jigsaws:

Maschine	Saw blade	Pendulum lifting step	Speed level	Saw cut
Festool PSC 420	Jigsaw blade Festool PLASTICS LAMINATE HM 90/3.3	3	6	sawn from underside

Please always note the settings and parameters recommended by the tool manufacturer.

3.2.3. DRILL

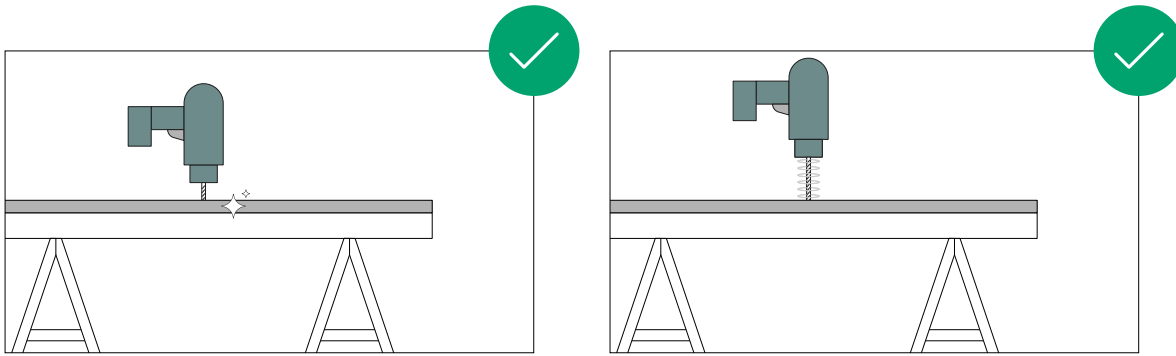

Use through-hole drill bits (point angle 60 – 80°) and support beams

Speed: approx. 1,500 rpm.

Products for machining. e.g.:

- MBE VHM façade panel drill bit with centring tip

Please always note the settings and parameters recommended by the tool manufacturer.

3.2.4. EDGE TREATMENT

We recommend chamfering sharp edges to prevent injuries during installation.

This can be done by CN machining, hand-guided edges or by hand.

Chamfering by hand is easy with a sanding block and sanding paper (grit size 100 – 400).

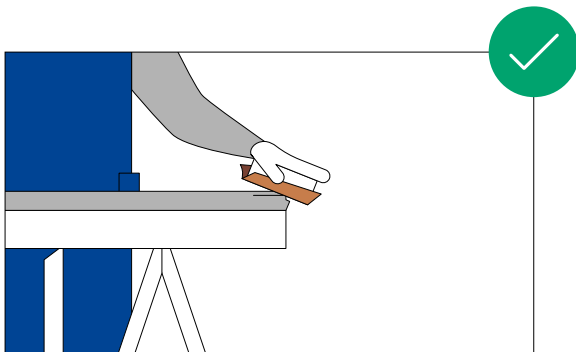

Suppliers of suitable materials tested in the Pfeleiderer system approval:

- Aluminium substructure (screw, rivet), and the TUF-S fastener, adapted to the Pfeleiderer decor range: [SFS Group Germany, de.sfs.com](https://www.sfs.com)
- Painted head fasteners (screw/rivet) adapted to the Pfeleiderer decor range: [SFS Group Germany GmbH | MBE Menden, www.mbe-menden.de](https://www.sfs.com)
- Fasteners (screw/bolt/rivet): [EJOT SE & Co. KG, www.ejot.de](https://www.ejot.de)

INSTALLATION



4. INSTALLATION

neuer Link hier?

Scan the QR code to watch our short installation videos.

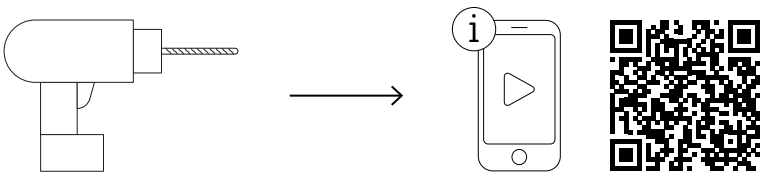

The diagram shows a power drill, followed by an arrow pointing to a smartphone displaying a play button icon, and another arrow pointing to a QR code.

The substructure must be assembled/installed according to the manufacturer's instructions and in compliance with the national standards. Corrosion-resistant materials must be used for the substructure.

General information:

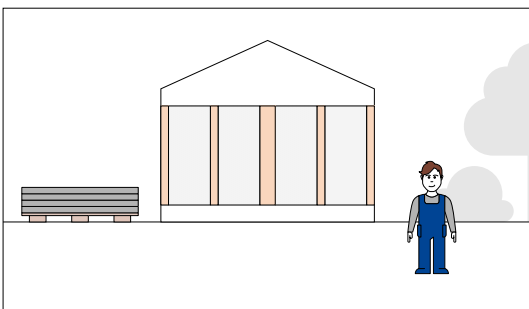

The substructure can be made of aluminium, stainless steel or timber, depending on the requirements and place of use.

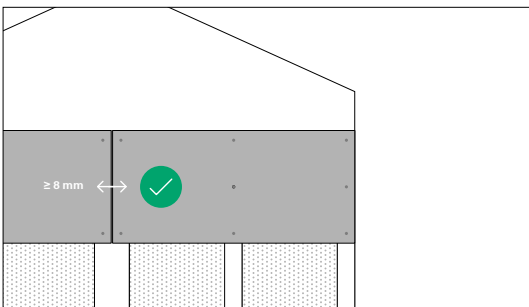

The substructure can be made of aluminium, stainless steel or wood, depending on the requirements and place of use.

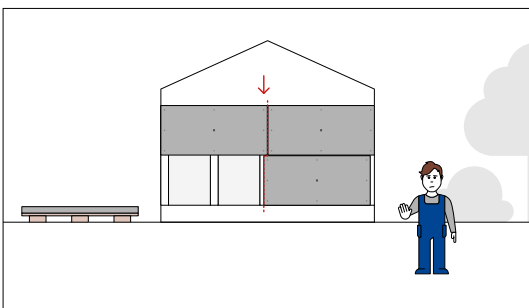

Align the expansion joint centrally on the substructure

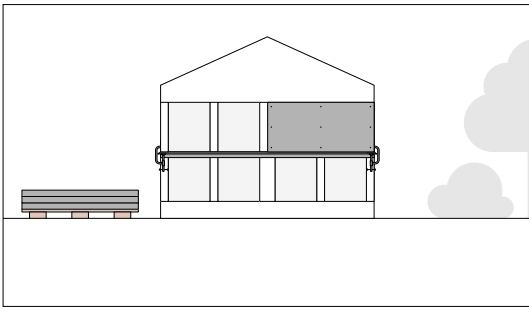

When fixing a panel, start in the middle of the panel.

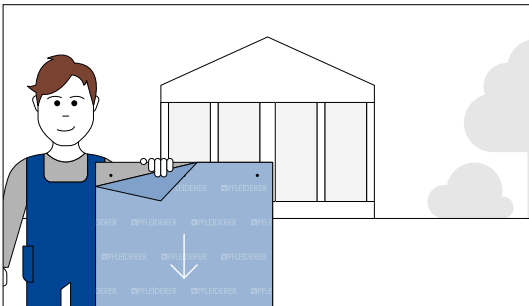

Installation of the panels in one direction is recommended (see arrow direction on the transport film).

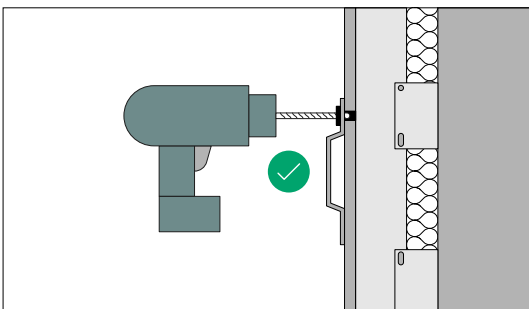

The centre of the drillhole in the panel and the substructure must match. To this end, use a suitable centralizing tool.

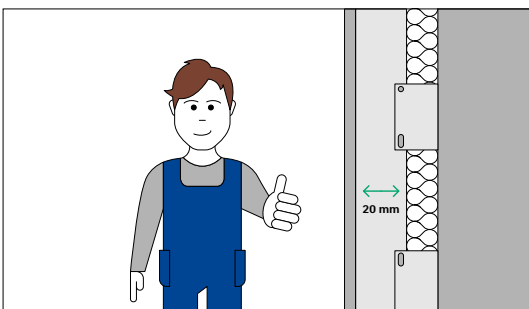

A ventilation gap of 20 mm must be maintained between the Duropal XTerior compact / Duropal XTerior compact F panel and the insulation material.

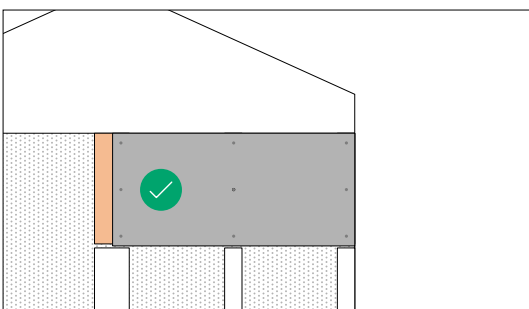

A Duropal XTerior compact / Duropal XTerior compact F panel must not be mounted on two different sections of the substructure. This enables uniform expansion of the substructure and the panel material.

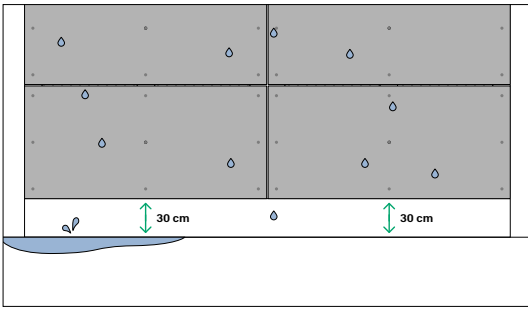

A plinth height of at least 30 cm must be adhered to.

Always comply with the regional construction regulations. The substructure and XTerior compact must be installed by skilled personnel.

Suppliers of suitable materials tested in the Pfeleiderer system approval:

- Aluminium substructure (screw, rivet), and the TUF-S fastener, adapted to the Pfeleiderer decor range: **SFS Group Germany, de.sfs.com**
- Painted head fasteners (screw/rivet) adapted to the Pfeleiderer decor range: **SFS Group Germany GmbH | MBE Menden, www.mbe-menden.de**
- Fasteners (screw/bolt/rivet): **EJOT SE & Co. KG, www.ejot.de**

4.1 VISIBLE FIXING ON METAL SUBSTRUCTURES – FOR NORMALLY FLAMMABLE AND FLAME RETARDANT FAÇADE SYSTEMS

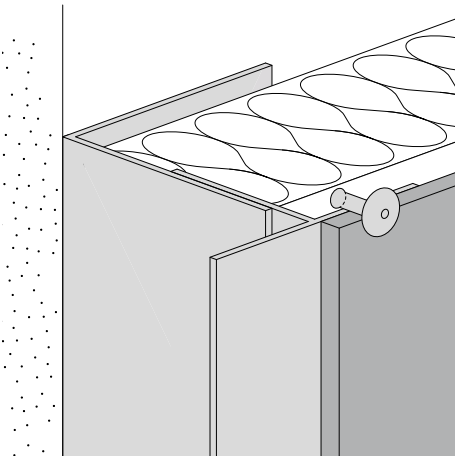

Ventilated curtain walls with visible fixing can be fixed with rivets, both with and without sleeve. By using painted head rivets in the respective decor colour of the panel, a homogeneous and high-quality façade appearance can be achieved.

4.1.1. REQUIREMENTS FOR THE ALUMINUM SUBSTRUCTURE

Different fasteners must be used depending on the requirement and installation situation. However, the material of the fasteners must correspond to the chosen metal substructure to prevent contact corrosion.

Substructure	Rivet material	Profile strength	Tensile strength	Yield point
aluminum	aluminum	1.8–3.0 mm	$R_m \geq 215 \text{ N/mm}^2$	$R_p 0.2 \geq 195 \text{ N/mm}^2$
e.g.: EN AW-6060 T66 or EN AW 6063 T6 after DIN EN 755-26				

Near sea level, in a direct industrial environment or in other installation situations in which there is an increased risk of corrosion, the substructure and rivets should be made of stainless steel.

Thicker profiles can also be used, if a longer rivet of the same type is used and the recommended jointed material thicknesses (grip ranges) are complied with.

4.1.2. FIXED AND SLIDING POINTS

Due to temperature changes and changes in humidity, length changes (shrinkage and swelling) occur in the façade panels and the substructure. The arrangement of movable points ensures that sufficient freedom to move is available for the panel.

To avoid deviations from the flatness, stable, planar execution of the substructure is to be used.

Equally, water logging is to be avoided in the design and installation. Regardless of the material used, the substructure must be protected against corrosion.

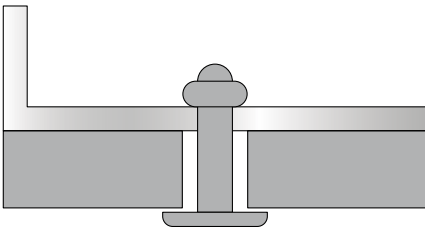

Movable point

Movable points are necessary to allow swelling and shrinking of the panel material and expansion of the substructure without restraints.

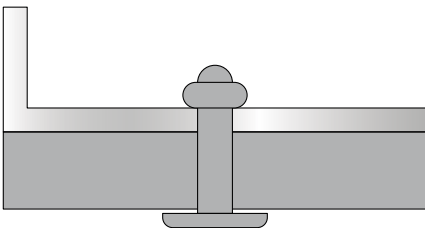

Fixed point

Fixed points are used to uniformly spread the expansion of the panel material and substructure over the entire panel. One fixed point is to be made for each panel.

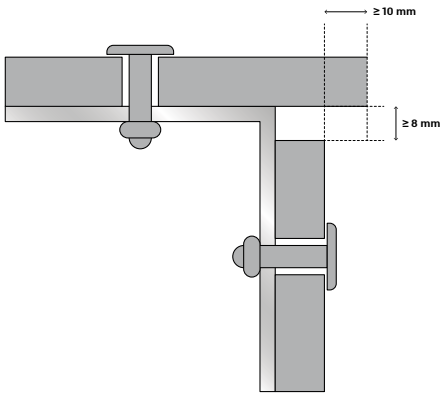

Making corners

A panel projection of 10 mm along the side panel is recommended to conceal construction tolerances from the main visible side.

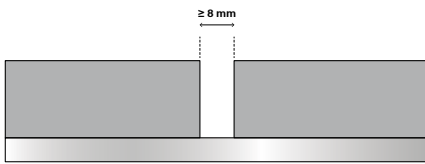

Expansion joints

Expansion joints of at least 8 mm must be maintained between the panel joints of Duropal XTerior compact / Duropal XTerior compact F.

4.1.3. CONSTRAINT-FREE INSTALLATION

To prevent stress damage, the riveted components must be able to be moved relative to each other. This is called an unrestrained joint. A special gauge matched to the chosen rivet is absolutely necessary to ensure this. The special gauge nosepiece is used without exception for all fixing points, i.e. fixed and movable points.

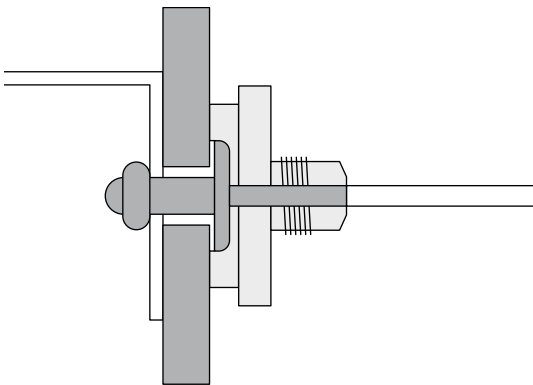

4.1.4. FASTENERS – RIVETS WITH HARD POINT SLEEVES

Mounting clip

OPTION 1: ALUMINIMUM SUBSTRUCTURE WITH RIVETS AND FIXED POINT SLEEVES



Scan the QR code
to watch the Pfleiderer
installation video.

The fixing with rivets and fixed point sleeves and fixed point sleeves with slotted hole, offer a particular advantage in the off-site production of the façade panels. As fixed points and movable points can only be determined on site by use of the corresponding sleeves, all drill holes can be drilled in advance with the same drillhole diameter of 10 mm. This accelerates production and offers increase flexibility during installation.

Aluminium facade rivet head dia 16 mm	L (mm)	Clamp range (mm)
	14	5.5–9.0
	16	7.0–10.5
	18	9.0–12.5
	21	12.0–15.5
	23	14.0–17.5
	25	15.5–19.5
Facade rivets manufacturer MBE	"MBE-FN-AL5-5 × 18 K16" in accordance with the general technical approval Z-10.3-698	
Facade rivets manufacturer EJOT	"ECORIV AL/E 5 × 16" in accordance with the general building approval Z-14.4-851	
Casing material	Al Mg 5 material no. EN AW-5019	
Rivet mandrel material	Stainless steel material no. 1.4541	
Borehole diameter fixed point / sliding point	10 mm	
Drill hole diameter of the metal substrate	5.1 mm	

Products for processing e.g.:	MBE article number
MBE Fixed point sleeve kit "Plus"	1240405
MBE Insertion tool	1360603
MBE Bracket drilling jig	1360218
MBE HSS drill bit for stirrup drill jig 5.1 mm	1360405
MBE Special Gauge Nose piece G3	1360307

Note:

A rivet setting gauge/nosepiece must be used for all fixing points, to ensure a distance from the rivet head to the surface of the panel of ≥ 0.3 mm.

Suppliers for suitable materials tested in the Pfeleiderer system approval:

Various manufacturers offer matching painted head rivets in all colours of the Pfeleiderer Duropal XTerior compact / Duropal XTerior compact F range and suitable accessories for assembly and installation.

- [SFS Group Germany, de.sfs.com](http://de.sfs.com)
- [SFS Group Germany GmbH | MBE Menden, www.mbe-menden.de](http://www.mbe-menden.de)
- [EJOT SE & Co. KG, www.ejot.de](http://www.ejot.de)

4.1.4. FASTENING AND EDGE DISTANCES

Single panel system

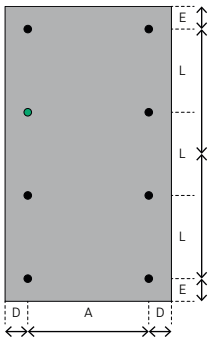

Multiple panel system

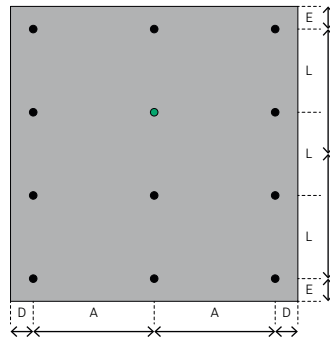

- Movable point
- Fixed point

Panel thickness (mm) Duropal XTerior Compact	Panel thickness (mm) Duropal XTerior Compact F	Max fixing distance A (mm)	Max fixing distance L (mm)	Edge spacing D (mm)	Edge spacing E (mm)
6.0	–	500	≤ 400	≥ 20	≥ 20
8.0	8.0	850	≤ 850	≥ 20	≥ 20
10.0	10.0	700	≤ 500	≥ 20	≥ 20

Maximum panel size (8 mm panel thickness):

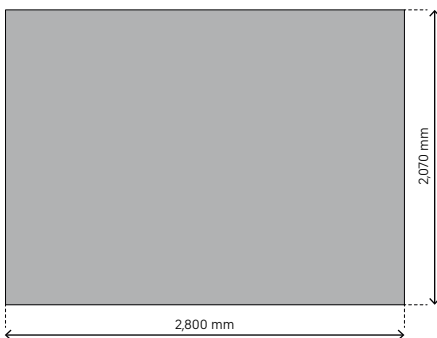

The maximum edge distance of 10 times the panel thickness must not be exceeded. The fixing spacings must be according to the structural requirements. If this is not necessary due to the local building regulations, use the values in the top table.

Panel sizes are production sizes and assume cutting to size on all sides to achieve necessary dimensional or angular accuracy.

4.1.5. ASSEMBLY PROCESS

By using a "plus" fixed point sleeve (with slotted hole) in a horizontal axis next to the classic fixed point sleeve, the longitudinal expansion of the panel is ensured and tipping/turning of the panel is prevented.

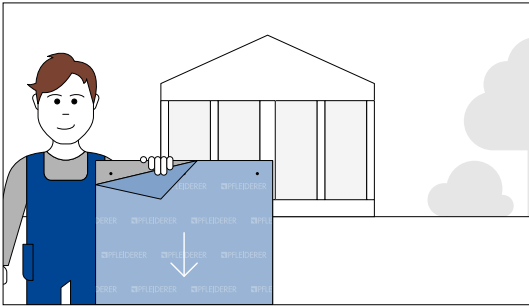

1. Pull the transport film off the surface of the panel before starting the installation at the latest.

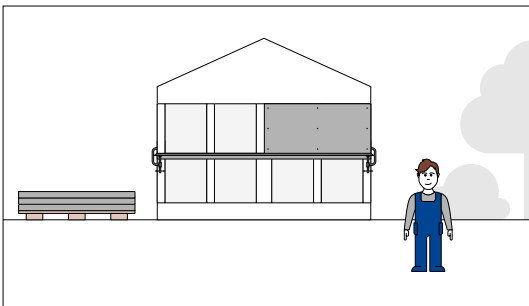

2. Transport drilled panels safely on the aluminium substructure and clamp in the target position with the mounting bracket and clamps.

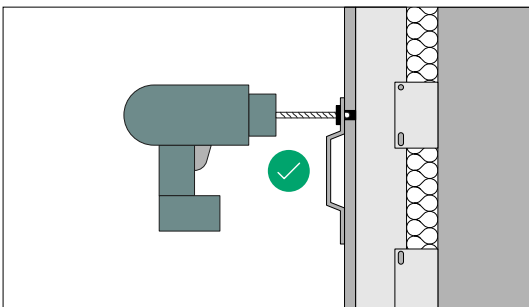

3. Centric transfer of the panel holes on the aluminium substructure with the help of a suitable drilling gauge or drilling jig

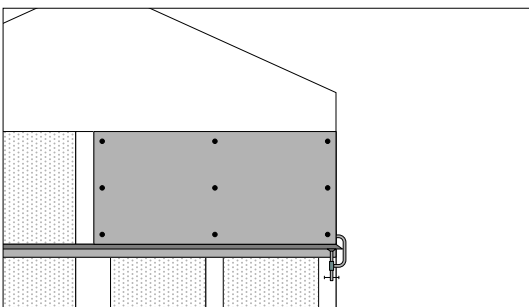

4. For determination of fixed point and "Plus" fixed point see **chapter 4.1.6**. Arrangement of the fixed point sleeves

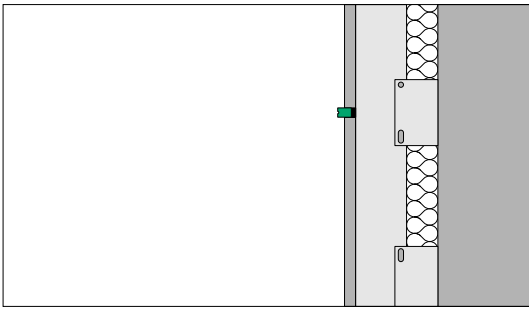

5. Insert the fixed point sleeve (FPH) 10/5.1 loosely into the panel hole

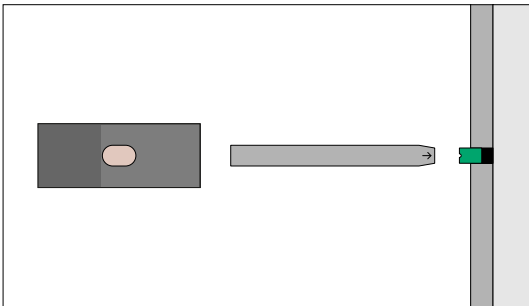

6. Use the hammer tool to drive the fixed point sleeve with slotted hole (FPH+) 10/5.2x7.7 into the panel hole chosen for the fixed point sleeve with slotted hole.
Use the above-named hammer tool to do this.
Important: The slotted hole must be positioned horizontally!

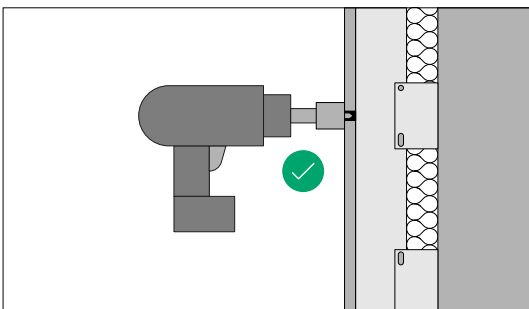

7. Use the special gauge nosepiece G3 to set the façade rivet

neuer Link
hier?

Scan the QR code to watch
our short installation videos.

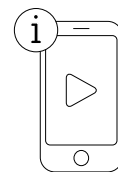
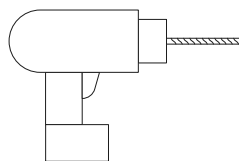
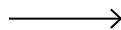

4.1.6. ARRANGEMENT OF THE FIXED POINT SLEEVES

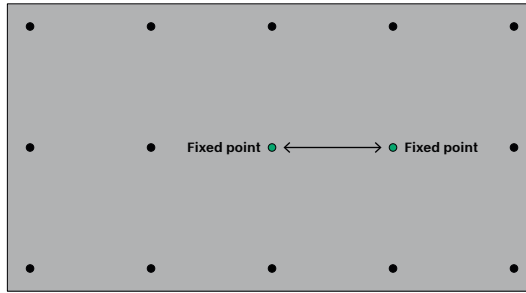
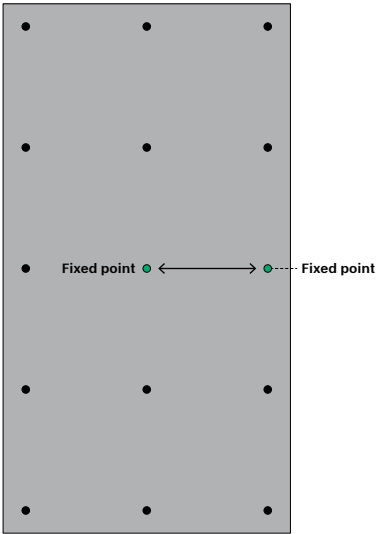

Symmetrical arrangements

The fixed point (FP) is exactly in the middle of the panel. The fixed point sleeve, together with the "Plus" fixed point sleeve, lies on a horizontal axis.

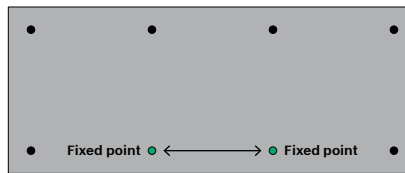
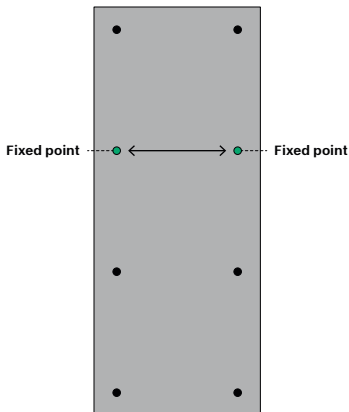

Asymmetrical arrangements

The middle of the panel is outside a fixing point.

The position of the fixing point (FP) is therefore defined as near possible to the middle of the panel. The fixed point sleeve, together with the "Plus" fixed point sleeve, lies on a horizontal axis.

4.1.7. FASTENERS – RIVETS

Mounting clip

OPTION 2: ALUMINIUM SUBSTRUCTURE WITH RIVETS



Scan the QR code
to watch the Pfleiderer
installation video.

Aluminium facade rivet head dia 14 mm	L (mm)	Clamp range (mm)
	16	7.0–10.5
	18	9.0–12.5
	21	12.0–15.5
	23	14.0–17.5
	25	15.5–19.5
Facade rivets manufacturer MBE	"MBE FN A15-5x18 K14" in accordance with the general building approval Z-10.3-698	
Casing material	Al Mg 5 material no. EN AW-5019	
Rivet Mandrel Material	Stainless steel material no. 1.4541	
Borehole diameter fixed point/sliding point	5.1 / 8.5 mm	
Drill hole diameter of the metal substrate	5.1 mm	

Near sea level, in a direct industrial environment or in other installation situations in which there is an increased risk of corrosion, the substructure and rivets should be made of stainless steel.

Products for processing e.g.	MBE article number
MBE Special Gauge Nose Piece Type G2	1360304
MBE Bracket drilling jig	1360217
MBE HSS drill bit for bracket drill jig 5.1 mm	1360405

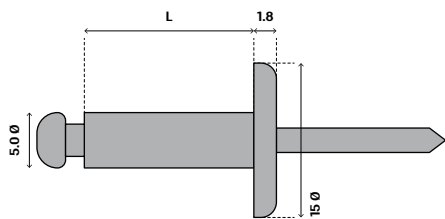
Stainless steel rivet**L (mm)****Clamp range (mm)**

14	4.0–9.0
18	8.0–13.0
22	12.0–17.0
27	17.0–22.0

Facade rivet manufacturer	MBE
Casing material	Stainless steel material no. 4578, AISI 316
Rivet mandrel material	Stainless steel material no. 1.4541, AISI 316 Ti
Borehole diameter fixed point/sliding point	5.1 / 8.5 mm
Drill hole diameter of the metal substrate	5.1 mm

Products for processing e.g.**MBE article number**

MBE Special Gauge Nose Piece Type G6	1360309
MBE Bracket drilling jig	1360217
MBE HSS drill bit for stirrip drill jig 5.1 mm	1360405

Note:

A rivet setting gauge/nosepiece must be used for all fixing points, to ensure a distance from the rivet head to the surface of the panel of ≥ 0.3 mm

Suppliers for suitable materials tested in the Pfeleiderer system approval:

Various manufacturers offer matching painted head rivets in all colours of the Pfeleiderer Duropal XTerior compact / Duropal XTerior compact F range and suitable accessories for assembly and installation.

- [SFS Group Germany, de.sfs.com](http://www.sfs.com)
- [SFS Group Germany GmbH | MBE Menden, www.mbe-menden.de](http://www.mbe-menden.de)
- [EJOT SE & Co. KG, www.ejot.de](http://www.ejot.de)

4.1.8. FASTENING AND EDGE DISTANCES

Single panel system

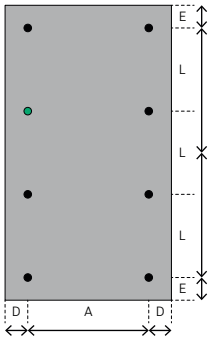

Multiple panel system

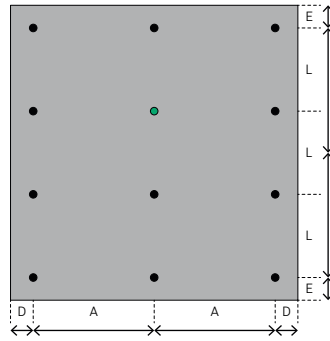

- Movable point
- Fixed point

Panel thickness (mm) Duropal XTerior Compact	Panel thickness (mm) Duropal XTerior Compact F	Max fixing distance A (mm)	Max fixing distance L (mm)	Edge spacing D (mm)	Edge spacing E (mm)
6.0	–	500	≤ 400	≥ 20	≥ 20
8.0	8.0	850	≤ 850	≥ 20	≥ 20
10.0	10.0	700	≤ 500	≥ 20	≥ 20

Maximum panel size (8 mm panel thickness):

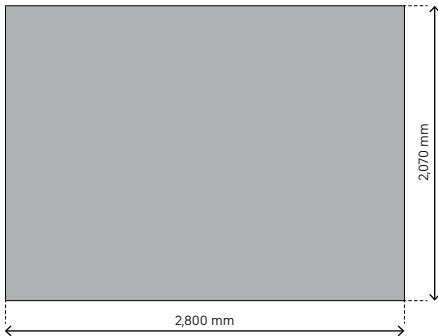

The maximum edge distance of 10 times the panel thickness must not be exceeded. The fixing spacings must be according to the structural requirements. If this is not necessary due to the local building regulations, use the values in the top table.

Panel sizes are production sizes and assume cutting to size on all sides to achieve necessary dimensional or angular accuracy.

4.1.9. ASSEMBLY PROCESS

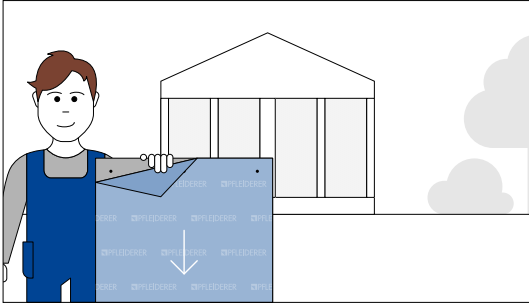

1. Pull the transport film off the surface of the panel before starting the installation

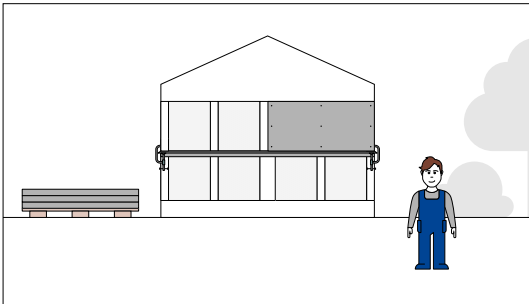

2. Place drilled panels on the aluminium substructure and clamp in the target position with the mounting bracket and clamps.

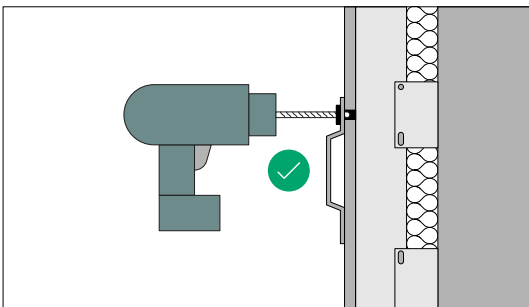

3. Centric transfer of the panel holes on the aluminium substructure with the help of a centralising tool

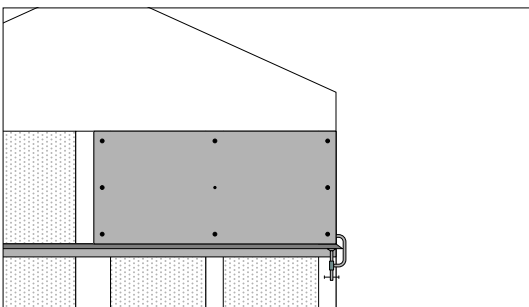

4. Fixed and movable points are already defined in the preproduction by the layout of the drillhole diameter.

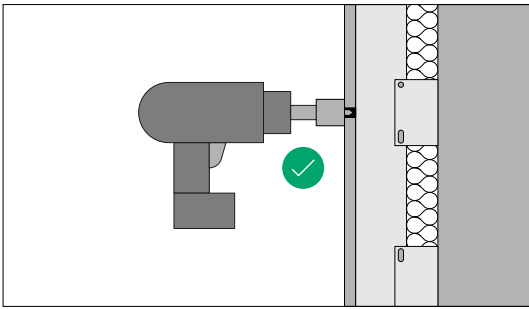

5. Use the special gauge nosepiece for unrestrained setting of the façade rivet

Scan the QR code to watch our short installation videos.

4.1.10. PLACEMENT OF FIXED AND SLIDING POINTS

When fixing with rivets without fixed point sleeves, the arrangement of the fixed and movable points is defined in the off-site production by the choice of drillhole diameter.

Fixed points should always be in the middle of the panel, in order to enable uniform expansion in the panel material and the substructure.

Movable points are drilled with 8.5 mm, fixed points with 5.1 mm. Each panel element has only one fixed point. All other fixing points are executed as movable points.

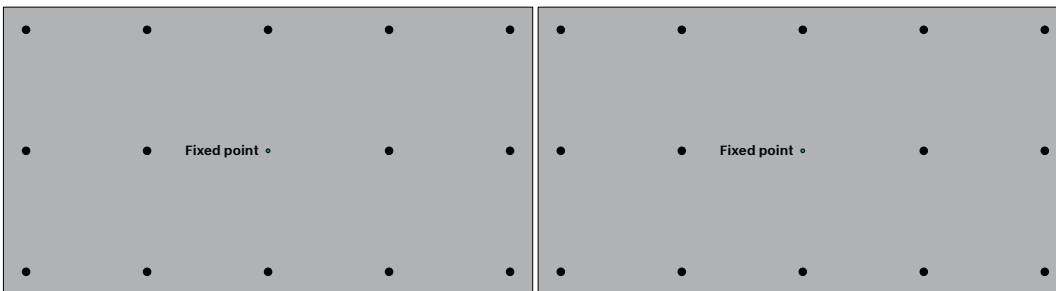

4.2. CONCEALED FIXING ON METAL SUBSTRUCTURE



The installation of Duropal XTerior compact / Duropal XTerior compact F panels with the TUF-S system of SFS intec GmbH on a metal substructure is specified for façade use by ETA-15/0476.

4.2.1. FASTENERS – NORMAL / FLAME RETARDANT



Horizontal SFS support sections (channels) are fixed onto the vertical profiles. corresponding brackets are fastened onto the back of the panel are then hooked into the support sections. Once they are adjusted and levelled, they are fixed onto the support rail with a fixing screw.

4.2.2. TUF-S CONNECTOR

The concealed fixing of the Duropal XTerior compact / Duropal XTerior compact F panels can be achieved using the TUF-S fasteners of SFS intec GmbH in accordance with ETA-15/0476. Different drilled depths are required depending on the panel thickness.

The radial widening on pulling out the mandrel causes the thread to punch into the façade panel and therefore results in very high pull-out values. The fastener (anchor) can therefore not be over-wound during installation. Independent reversing due to dilation or vibration is not possible. When pre-drilling, a residual thickness of the Duropal XTerior compact / Duropal XTerior compact F panel of at least 3 mm must be maintained.

Fasteners	TUF-S fastener length (mm)	Duropal XTerior compact panel thickness (mm)	Agraffe profile thickness (mm)	Drill hole depth (mm)
TUF-S-6 x 7-A4	7	8	2.0	5.0
TUF-S-6 x 8-A4	8	8	3.0	5.0
TUF-S-6 x 9-A4	9	8	4.0	5.0
	9	10	2.0	7.0
	9	10	2.5	6.5
TUF-S-6 x 10-A4	10	10	3.0	7.0
	10	10	4.0	6.0
	10	12	2.0	8.0
	10	12	2.5	7.5
	10	12	3.0	7.0
	10	12	4.0	6.0
TUF-S-6 x 11-A4	11	12	2.0	9.0
	11	12	2.5	8.5
	11	12	3.0	8.0
	11	12	4.0	7.0
TUF-S-6 x 12-A4	12	12	3.0	9.0
	12	12	4.0	8.0
TUF-S-6 x 13-A4	13	12	4.0	9.0

Accessories

Depth gauge for blind drilling



Solid carbide drill bit

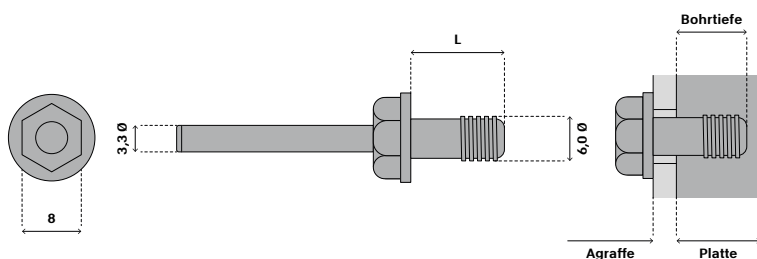

Suppliers of suitable materials tested in the Pfeleiderer system approval:

The TUF-S connector and materials for production of the substructure can be purchased, for example, from SFS:

- [SFS Group Germany, de.sfs.com](https://www.sfs.com)

4.2.3. HOLE MAKING

When drilling the holes, ensure that the visible side of the Duropal XTerior compact / Duropal XTerior compact F panels is placed on a clean surface so that the panel is not damaged.

The façade panels must each be positioned with full surface contact so that the panel is not deflected or damaged by the drilling pressure.

If the drilling is carried out with the depth stop and the suitable HSS drill bit, the hole is made properly if the depth stop touches the back of the Duropal XTerior compact / Duropal XTerior compact F panels and a uniform visible ring forms around the drillhole.

On pulling out the mandrel, for example, using the GESIPA PowerBird® Pro, a light pressure must be exerted on the TUF-S blind fastener. The rivet is correctly inserted if the bracket is fixed or can only be moved by a minimum amount.



Drill bits with a "Depth Locator" depth stop must be used to drill the blind holes.

Depth gauge "Depth Locator"

Source: SFS intec GmbH

Description	For drilling depth (mm)
Depth gauge "Depth Locator"	SFS-order number: 1478567
HSS-6.0 x 40	5.0
HSS-6.0 x 40.5	5.5
HSS-6.0 x 41	6.0
HSS-6.0 x 41.5	6.5
HSS-6.0 x 42	7.0
HSS-6.0 x 42.5	7.5
HSS-6.0 x 43	8.0
HSS-6.0 x 43.5	8.5

The precise positioning and number of fixed points and drill holes required is generally specified in the installation drawing and is defined by the structural calculations.

4.2.4. ASSEMBLY PROCESS

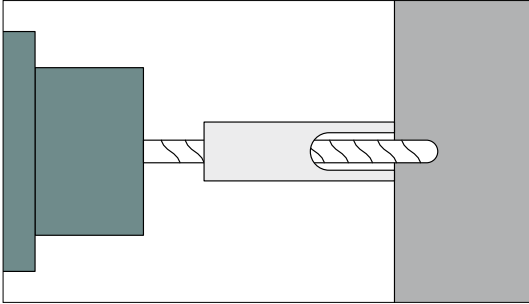

1. Pre-drilling of the Duropal XTerior compact / Duropal XTerior compact F panels with the HSS blind hole drill bit \varnothing 6 mm with depth stop or with a CNC machining centre

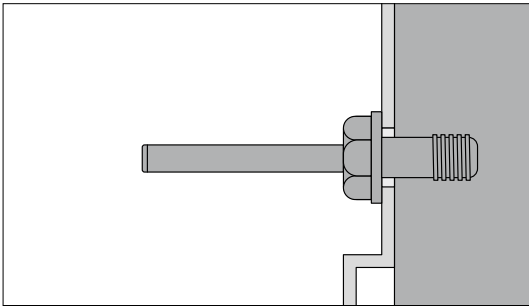

2. Position the panel bracket with the predrilled holes and push with predrilled holes and pushing through the TUF-S blind fastener.

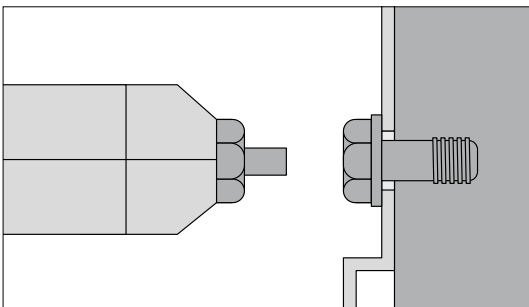

3. Completely pull out the mandrel, e.g. using the GESIPA® PowerBird® Pro rivet gun (nosepiece 17/36 or 17/40)

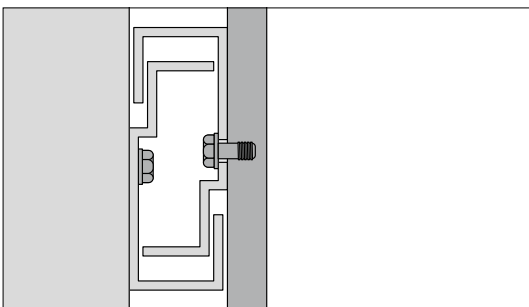

4. Hooking the prefabricated façade elements into the horizontal support sections attached to the façade substructure

4.3. VISIBLE FIXING ON TREATED TIMBER SUBSTRUCTURE – FOR NORMALLY FLAMMABLE FAÇADE SYSTEMS

Mounting clip

OPTION 3:
WOOD SUBSTRUCTURE
WITH SCREWS



Scan the QR code
to watch the Pfleiderer
installation video.

4.3.1. FASTENERS – SCREW FOR TIMBER SUBSTRUCTURE

The Duropal XTerior compact / Duropal XTerior compact F panels can be mounted on vertical support sections made of wood with the help of façade screws.

In addition, the substructure must be protected between the wood battens and the Duropal XTerior compact / Duropal XTerior compact F with an EPDM jointing tape at least 1.2 mm thick and min. 10 mm projection on both sides.

The locally relevant guidelines must always be used for the construction and design.

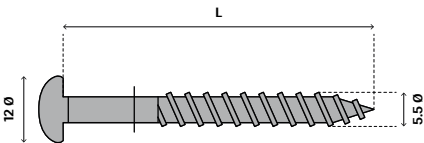
Stainless steel screw	L (mm)	Diameter (mm)
	35	5.5
Material	Stainless steel	
Drill hole diameter Duropal XTerior compact fixed point / movable point	5.6 / 8.0 mm	

Products for processing e.g.:	Article number
MBE Bracket drilling jig	1360222
MBE HSS Twist Drill Ø3.3	1360409
Festool Depth gauge DC UNI FF	769126

Suppliers for suitable materials tested in the Pfeleiderer system approval:

Various manufacturers offer matching painted head rivets in all colours of the Pfeleiderer Duropol XTerior compact range and suitable accessories for assembly and installation.

- [SFS Group Germany, de.sfs.com](http://de.sfs.com)
- [SFS Group Germany GmbH | MBE Menden, www.mbe-menden.de](http://www.mbe-menden.de)
- [EJOT SE & Co. KG, www.ejot.de](http://www.ejot.de)

4.3.2. FASTENING AND EDGE DISTANCES

Single panel system

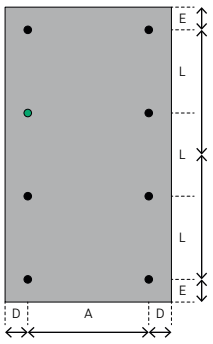

Multiple panel system

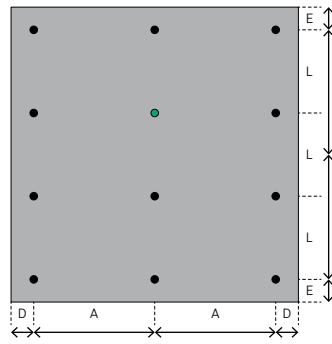

- Movable point
- Fixed point

Panel thickness (mm) Duropol XTerior Compact	Panel thickness (mm) Duropol XTerior Compact F	Max. fixing distance A (mm)	Max. fixing distance points L (mm)	Edge spacing D (mm)	Edge spacing E (mm)
6.0	–	500	≤ 400	≥ 20	≥ 20
8.0	8.0	850	≤ 850	≥ 20	≥ 20
10.0	10.0	700	≤ 500	≥ 20	≥ 20

The maximum edge distance of 10 times the panel thickness must not be exceeded.

The fixing spacings must be according to the structural requirements. If this is not necessary due to the local building regulations, use the values in the top table.

Panel sizes are production sizes and assume cutting to size on all sides to achieve necessary dimensional or angular accuracy.

4.3.3. ASSEMBLY PROCESS

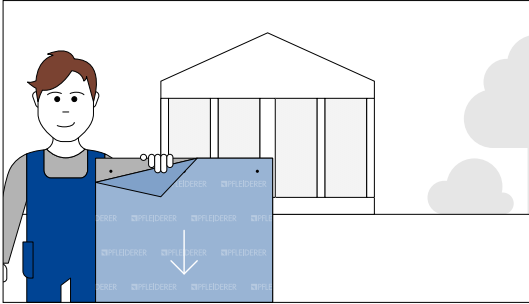

1. Pull the transport film off the surface of the panel before starting the installation.

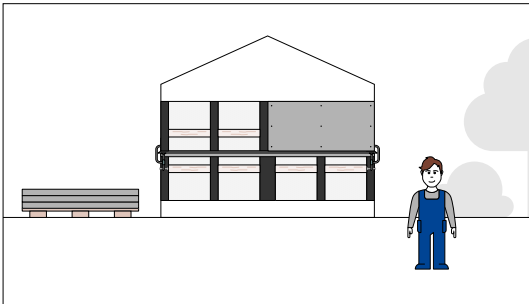

2. Place drilled panels on the wood substructure and clamp in the target position with the mounting bracket and clamps.

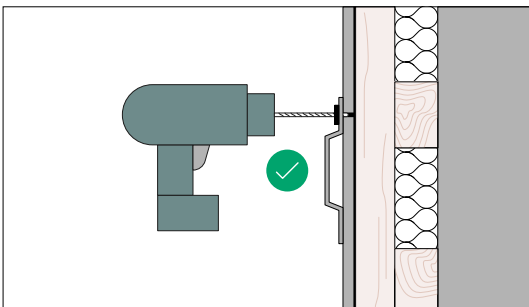

3. Centric transfer of the panel holes onto the wood substructure with the help of a centralizing tool.

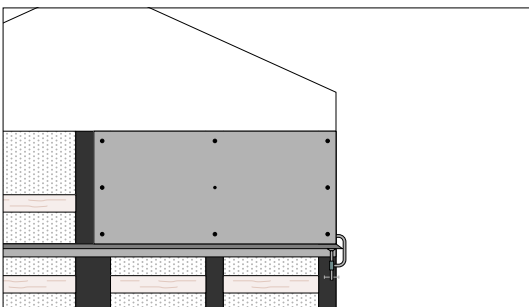

4. Fixed and movable points are already defined in the preproduction by the layout of the drillhole diameter.

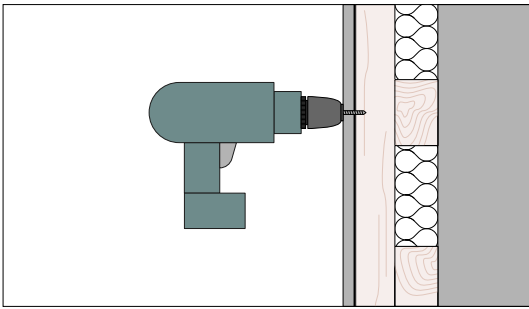

5. A depth stop must be used for all fixing points, to ensure a distance from the screw head to the surface of the panel of ≥ 0.3 mm. If use of a depth stop is not possible, the screw must be tightened to a suitable chosen torque and then turned back out of the substructure by a quarter turn.

Scan the QR code to watch our short installation videos.

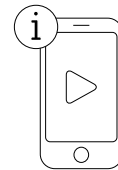
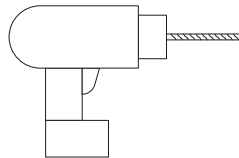

4.3.4. FIXED AND SLIDING POINTS

Due to the temperature changes and changes in humidity, minimal length changes occur in the façade panels and the substructure. The arrangement of movable points ensures that sufficient freedom to move is available for the panel.

Screws in movable and fixed points must not be tightened, as otherwise the panels can arch between the fixed points. To prevent this, the screw must be tightened to a suitable chosen torque and then turned back out of the substructure by a $\frac{1}{4}$ turn.

In addition, the substructure must be protected by an EPDM joint tape with a side projection of at least 10 mm and a minimum thickness of 1.2 mm.

Note:

A depth stop must be used for all fixing points, to ensure a distance from the screw head to the surface of the panel of ≥ 0.3 mm. If use of a depth stop is not possible, the screw must be tightened to a suitable chosen torque and then turned back out of the substructure by a quarter turn.

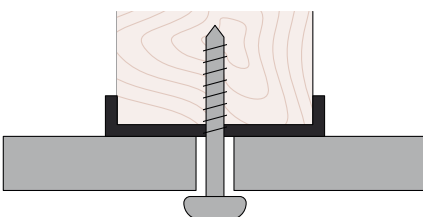

Movable point

Movable points are necessary to allow swelling and shrinking of the panel material and expansion of the substructure without restraints.

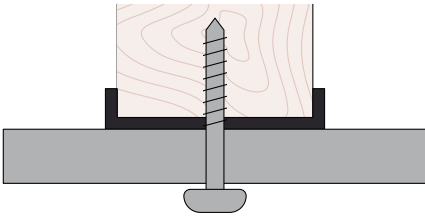

Fixed point

Fixed points are used to uniformly spread the expansion of the panel material and substructure over the entire panel. One fixed point is to be made for each panel.

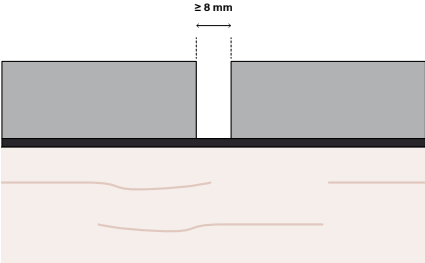

Expansion joints

Expansion joints of at least 8 mm must be maintained between the panel joints of Duropal XTerior compact / Duropal XTerior compact F.

4.4. BALCONY BALUSTRADES

The design of balconies and balcony railings is an important element in the design of buildings.

With Duropal XTerior compact / Duropal XTerior compact F panels there are no limits to the design of the balcony railings, in addition the fall protection requirements are fulfilled.

4.4.1. FASTENER – RIVET

Alu-rivet

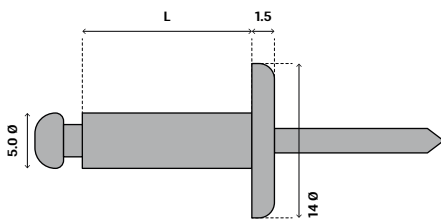

L (mm)

Clamp range (mm)

16	7.0 – 10.5
18	9.0 – 12.5
21	12.0 – 15.5
23	14.0 – 17.5
25	15.5 – 19.5

Casing material

Al Mg 5 material Nr. EN AW-5019

Rivet mandrel material

Stainless steel material no. 1.4541

Drill hole diameter fixed/sliding point

5.1 / 8.5 mm

Drill hole diameter of the metal substrate

5.1 mm

The rivets must be set, unrestrained, using a special setting nosepiece, the clearance should be 0.3 mm.

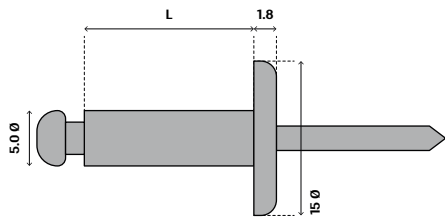
Stainless steel rivet**L (mm)****Clamp range (mm)**

14	4.0–9.0
18	8.0–13.0
22	12.0–17.0
27	17.0–22.0

Rivet manufacturer MBE

"MBE-FN-A4-5 x L K15" according to European Technical Assessment E TA-21/0951

Casing material

Stainless steel material no. 1.4578, AISI 316

Rivet mandrel material

Stainless steel material no. 1.4541, AISI 316 Ti

Drill hole diameter fixed/sliding point

5.1 / 8.5 mm

Drill hole diameter of the metal substrate

5.1 mm

The rivets must be set, unrestrained, using a special setting nosepiece, the clearance should be 0.3 mm.

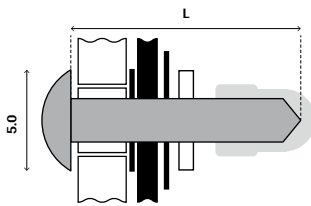
Balcony bolt**L (mm)****Clamp range (mm)**

25	12.0–16.0
30	17.0–21.0

Drill hole diameter fixed/sliding point

6.0 / 8.5 mm

Drill hole diameter of the metal substrate

6.0 / 6.0 mm

4.4.2. MOUNTING AND EDGE DISTANCES

Single panel system

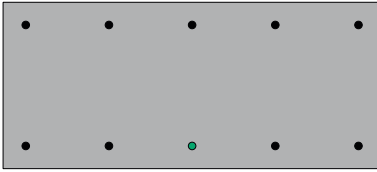

Fixed point below centre

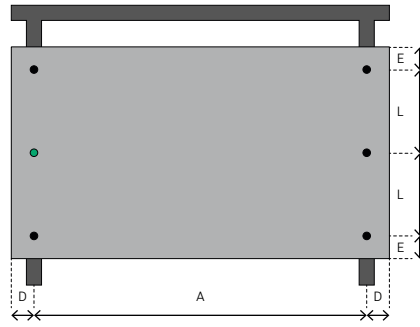

Visible fixing to posts

- Movable point
- Fixed point

Multiple panel system

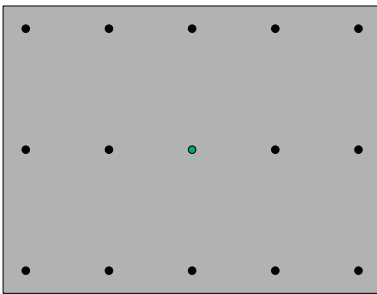

Fixed point panel centre

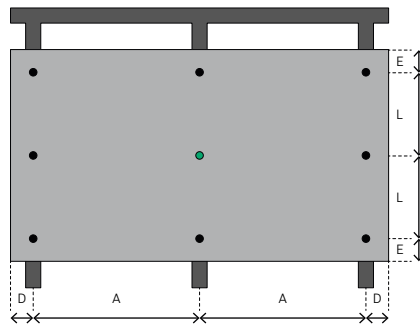

Visible fixing to posts

- Movable point
- Fixed point

Panel thickness (mm)	Max. fastening clearance A (mm)	Max clearance fixing points L (mm)	Edge spacing D (mm)	Overhang clearance E (mm)	Guardrail height (mm)
Rivet					
8.0	≤ 900	≤ 480	≥ 20	≥ 20	900–1,100
10.0	≤ 1,000	≤ 480	≥ 20	≥ 20	900–1,100
Screw					
8.0	≤ 1,000	≤ 500	≥ 20	≥ 20	900–1,100
10.0	≤ 1,000	≤ 500	≥ 20	≥ 20	900–1,100

The rivets must be set, unrestrained, using a special setting nosepiece, the clearance should be 0.3 mm.

Panel sizes are production sizes and assume cutting to size on all sides to achieve necessary dimensional or angular accuracy.

4.4.3. GLASS CLAMPS

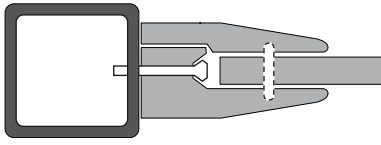

Glass clamp with locking pin

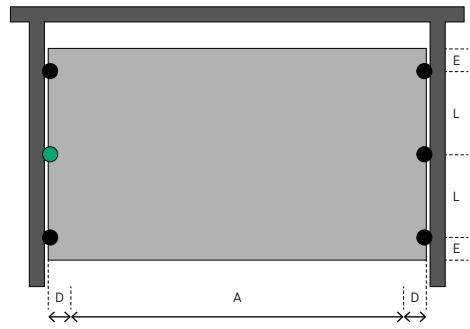

Fixing with glass clamps

- Glass clamp
- Glass clamp with locking pin

One locking pin is to be used for each panel; the pin protects the panels from falling if the clamping action reduces.

Panel thickness (mm)	Max. fastening clearance A (mm)	Max clearance fixing points L (mm)	Edge spacing D (mm)	Overhang clearance E (mm)	Guardrail height (mm)
8.0	≤ 1,000	≤ 480	≥ 20	≥ 20	900–1,100
10.0	≤ 1,040	≤ 480	≥ 20	≥ 20	900–1,100

DETAILED DRAWINGS



5. DETAILED DRAWINGS

5.1. RIVETS ON ALUMINIUM SUBSTRUCTURE

Head detail

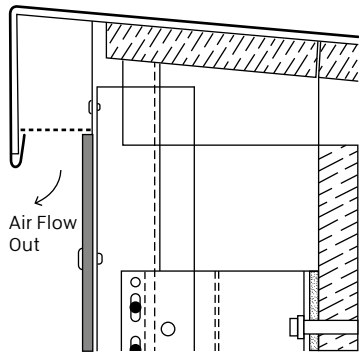

Vertical joint

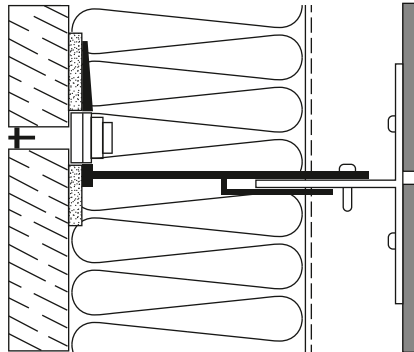

Plinth detail

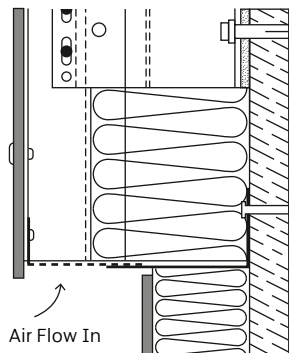

Horizontal joint

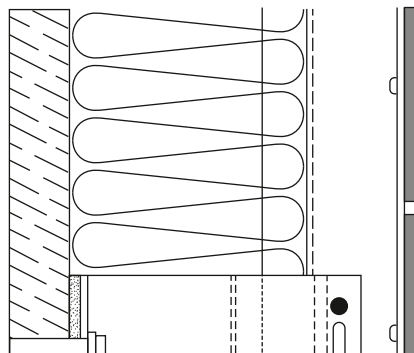

Internal corner detail

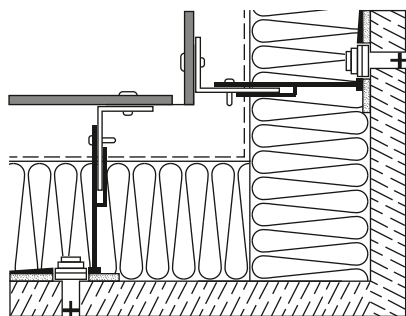

External corner detail

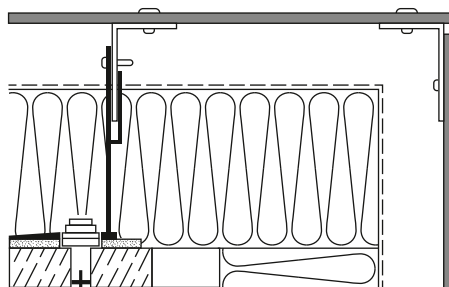

Window cill detail

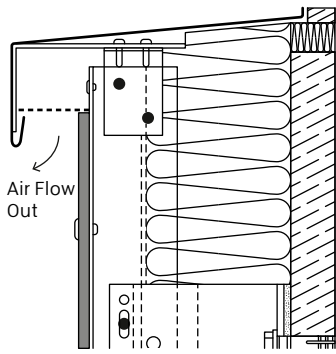

Window head detail

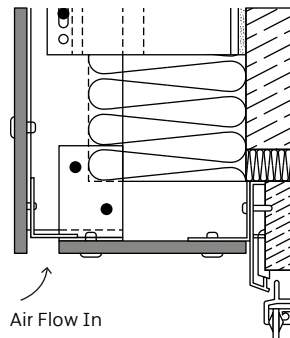

Window jamb detail

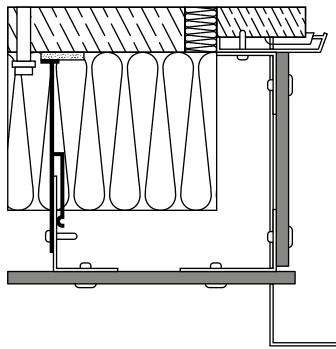

5.2. SECRET FIX (CLAMP OR BRACKET) SYSTEM ON ALUMINIUM SUBSTRUCTURE

Head Detail

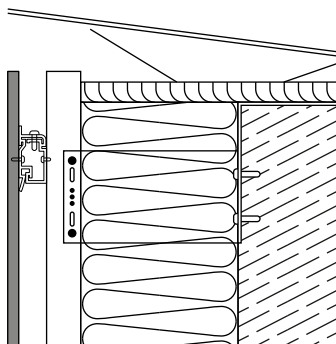

Vertical joint

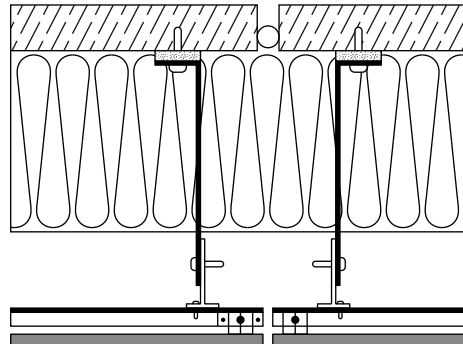

Base detail

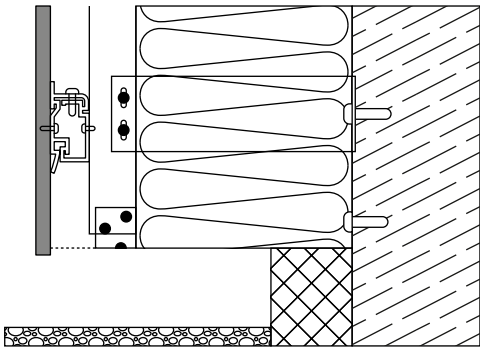

External corner

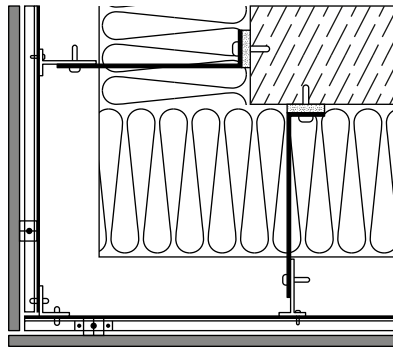

Internal corner

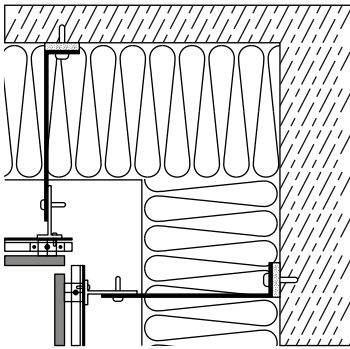

External corner detail with a corner profile

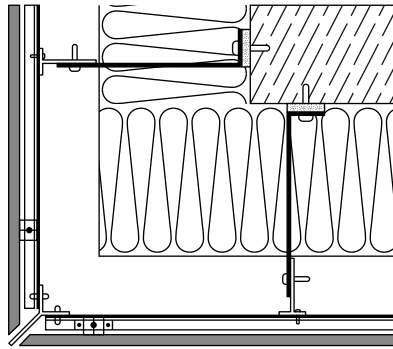

5.3. SCREW ON WOOD SUBSTRUCTURE

Head detail

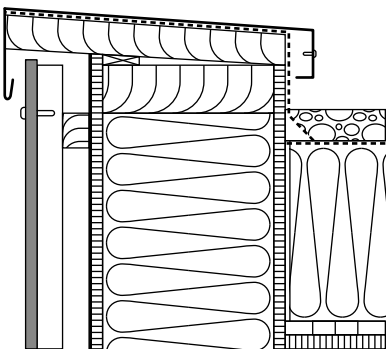

Vertical joint detail

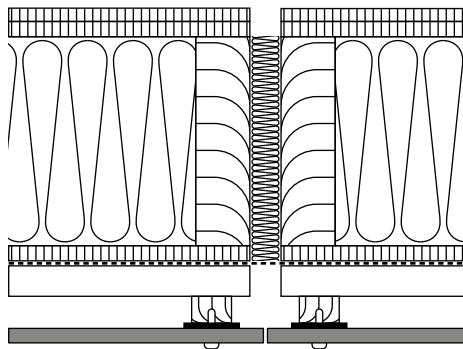

Plinth detail

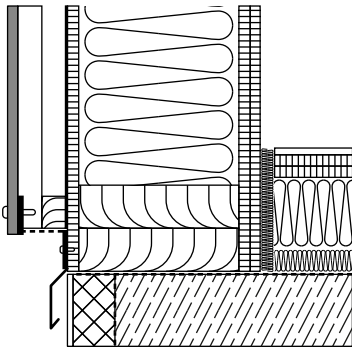

External corner detail

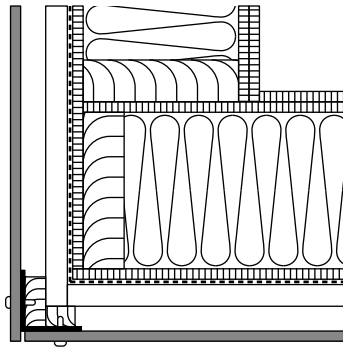

internal corner detail

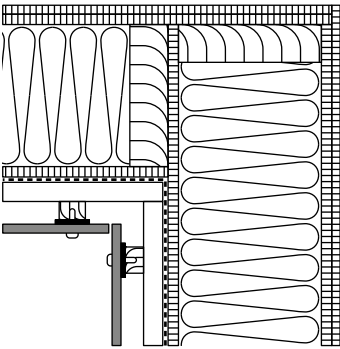

External corner detail with a corner profile

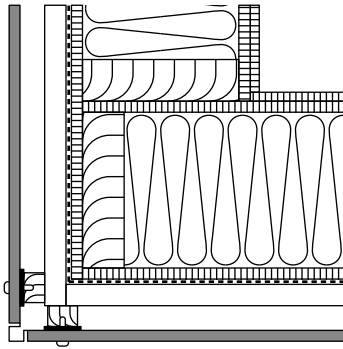

Window sill detail

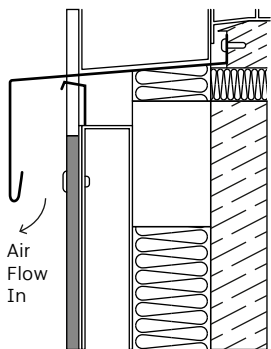

Window head detail

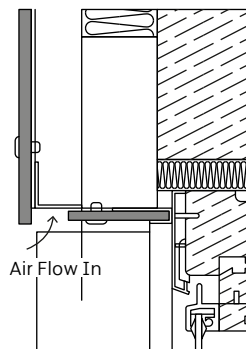

NOTES ON CARE AND CLEANING



6. NOTES ON CARE AND CLEANING

Duropol XTerior compact / Duropol XTerior compact F panels are characterised by their excellent material properties. They are durable, hygienic and easy-care. However, any contaminations or dirt of any form should be removed straight away if possible.

Please note the following information to achieve an optimum care and cleaning effect and to retain the material surface properties long-term.

6.1. BASIC CLEANING

The basic cleaning is used for dirt under normal use conditions.

The basic cleaning of coated surface is carried out by regular use of a mild soapy solution. Heavier soiling or more stubborn dirt should be given the opportunity to soak. The damp surface is then wiped down with warm, clean water until all residues of the cleaning agent have been removed.

Then rub dry with a dry, lint-free cloth, where possible in the “decor direction” or uniformly in one direction. Do not use cleaning agents, cloths or sponges that contain abrasive constituents. Abrasive constituents and / or movements can irreparably damage the fine texture of the surface! So-called “Balsam” washing-up liquids are also unsuitable cleaning substances. The skin care substances they contain form a film on the product surface that is very difficult to remove.

Furthermore, alcohol-based cleaning products (e.g. glass cleaning products) or even pure plastic cleaning products are also completely unsuitable.

Also, contact with aggressive cleaning products or descalers/water softeners should not be used, but if they are, then they should only remain on the surface for a very short time. Drips must be removed immediately. Longer action of these reagents may result in the formation of micro-cracks or embrittlement of the surface with subsequent irreparable stains, marks or scum (residues). As far as we are aware, the surfaces can be kept perfectly clean if these instructions are followed.

6.2. SPECIAL CLEANING – GRAFFITI

Graffiti can usually be removed with lacquer thinner. It must be noted that the lacquer thinner requires a short application time of a few seconds. The surface is then cleaned with water and is dried with a clean, soft, absorbent cloth. If this cleaning recommendation is followed, the lacquer thinner does not have any negative effect on the coated surface. This means that graffiti can also be removed several times from the same place.

7. RECOMMENDATIONS FOR FASTENER AND TOOL MANUFACTURERS

Façade, parapets and partition walls:

SFS Group Germany, de.sfs.com

Division Construction
In den Schwarzwiesen 2, 61440 Oberursel, Deutschland
Telefon: +49 (0) 6171 700 20, Fax: +49 (0) 6171 700 23 2
Vorgehängte hinterlüftete Fassade | SFS

SFS Group Germany GmbH I MBE Menden

Siemensstraße 1, 58706 Menden, Deutschland
Telefon: + 49 (0) 2373 / 17430-0, Fax: + 49 (0) 2373 / 17430-11
Home – MBE – Moderne Befestigungselemente – Menden (mbe-menden.de)

EJOT SE & Co. KG

Market Unit Construction
In der Stockwiese 35, 57334 Bad Laasphe, Deutschland
Telefon: +49 (0) 2752 / 908-0
EJOT | Spezialist der Verbindungs- & Befestigungstechnik

Möbelbeschläge und Verbindungsmittel für Outdoormöbel:

Häfele GmbH & Co KG

Adolf-Häfele-Str. 1, 72202 Nagold, Deutschland
Telefon: +49 (0) 74 52 / 95 – 0, Fax: +49 (0) 74 52 / 95 - 2 00
www.haefele.de

Hettich Holding GmbH & Co. oHG

Vahrenkampstraße 12-16, 32278 Kirchlengern, Deutschland
Telefon: +49 5223 / 77-0, Fax: +49 (0) 5223 / 77-1414
www.hettich.com

Adolf Würth GmbH & Co. KG

Reinhold-Würth-Straße 12-17, 74653 Künzelsau-Gaisbach, Deutschland
Telefon: +49 (0) 7940 15-0, Fax: +49 (0) 7940 15-1000
www.wuerth.de

Werkzeughersteller:

Emil Leitz GmbH

Leitzstrasse 2, 73447 Oberkochen
Tel: + 49 (0) 7364 - 950 - 0, Fax: + 49 (0) 7364 - 950 - 660
service-hotline@leitz.org

Festool GmbH

Wertstraße 20
D-73240 Wendlingen a.N.
www.festool.de

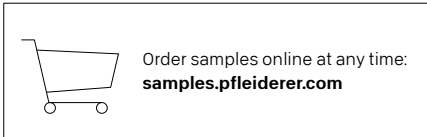

Decor Scanner
workapp.pfleiderer.com



© Copyright 2023 Pfleiderer Deutschland GmbH.

This information is issued with great care. We do not however accept any responsibility for the accuracy, completeness and timeliness. There may be slight colour differences between the printed brochure image and the actual design

Due to the continuous development and modification of our products, possible changes to the relevant standards, laws and regulations, our technical data sheets and product documents expressly do not represent a legally binding guarantee of the properties specified therein. In particular, no suitability for a specific purpose can be derived from this information. It is therefore the personal responsibility of the individual user to check the processing and suitability of the products described in this document for the intended use and to take into account the legal framework and the current state of the art. Furthermore, we expressly refer to the validity of our general terms and conditions.

You can find our general terms and conditions on our webpage: www.pfleiderer.com

Pfleiderer uses wood from Certified Sustainable Forest Management.



www.blauer-engel.de/uz76

- low emissions
- wood from sustainable forestry
- no adverse impact on health in the living environment

MADE IN GERMANY

Good to know: the Pfleiderer quality promise.

Pfleiderer wood-based panels stand for quality without compromise. We use sustainable raw materials and state-of-the-art production processes and we are fully committed to our site in Germany. For more information, visit quality.pfleiderer.com.

Pfleiderer UK Limited · Greenway House · Larkwood Way · Tytherington Business Park · Macclesfield · Cheshire SK10 2XR · England
Tel.: +44 (0) 16 25 660 410 · info-uk@pfleiderer.com · www.pfleiderer.com

Pfleiderer Deutschland GmbH · Ingolstädter Straße 51 · 92318 Neumarkt · Deutschland
Tel.: +49 (0) 91 81 / 28 480 · Fax: +49 (0) 91 81 / 28 482 · info@pfleiderer.com · www.pfleiderer.com